

**STAFF REPORT FOR CALENDAR ITEM NO.:** 10.4  
**FOR THE MEETING OF:** November 14, 2019

**TRANSBAY JOINT POWERS AUTHORITY**

**BRIEF DESCRIPTION:**

Authorize the Executive Director to complete negotiations and execute a lease agreement with Spring Fertility Management LLC for about 2,541 square feet of interior commercial/retail space on the second level of the transit center (spaces number 222 and 224) for a 15 year term.

**EXPLANATION:**

Commercial/Retail Leasing Background

As Phase I of the Transbay Program (Program) progresses toward completion, the TJPA is activating one of the elements of the Program—approximately 100,000 square feet of commercial/retail areas located on the ground, second, and park levels. Activating the commercial/retail areas entails completing lease agreements with commercial, retail, and service businesses.

In March 2017 the TJPA Board authorized an Asset Management Agreement (AMA) with a team led by Lincoln Property Company (Lincoln) for the transit center. Lincoln is overseeing the management of the transit center and, with its team member, Colliers International (Colliers), who is also managing the commercial/retail leasing of the transit center. One factor that contributed to the TJPA's selection of the Lincoln team for the AMA was the Lincoln team's revenue and expense projections. Specifically, the Lincoln team projected stabilized retail revenues of \$5.51 million annually, excluding percentage rent. The Lincoln team projected an initial capital expenditure for tenant improvements of \$27.10 million.

In May 2017 the Lincoln team presented to the TJPA Board a draft Retail Vision for the new transit center. The draft Retail Vision introduced, among other things, a proposed mission statement, an assessment of customer draw to the transit center, proposed programming based on expected day of the week and time of day of customer use, an explanation of potential tenant categories, a proposed merchandising logic based on location within the transit center, and a proposed commercial/retail space plan.

In July 2017 the TJPA Board approved the Retail Merchandising Plan (Plan) with the categories of dry goods, food/entertainment, market/food hall, and services. The Board authorized the Lincoln team to begin marketing and negotiations for commercial/retail leasing consistent with the Plan for approximately 100,000 square feet of space comprised of approximately 35 leases. In general, the Plan contemplates a mix of food retailers on the ground floor characterized as either short stay (impulse quick service food) or extended stay (table service restaurants). On the second floor, the Plan anticipates uses including office, services, fitness, beauty, food hall/cooking school/farmers market, and traditional grocer. At the park level, there are spaces for a full-service restaurant and a café. The Plan anticipates leasing to a mix of businesses that offer goods and services at all price points to ensure that the transit center is accessible and appealing

to a diverse population. The Plan anticipates certain demand from consumers and users of the transit center for local merchants.

In October 2017 the TJPA Board adopted a Retail Leasing Policy (Policy) that, among other things, authorizes the Executive Director to execute certain leases consistent with the Policy. The parameters within which the Executive Director can execute a lease under the Policy are: (a) initial term of 10 years or less (with no more than two options to extend at no more than five years each); (b) \$1.8 million or less in stated base rent in the aggregate over the initial term (exclusive of any participation rent or other revenue); (c) tenant improvement allowance of not more than \$150 per square foot; (d) lease agreement in substantially the form of the lease agreement template attached to the Policy; (e) lease generally consistent with the most recent Plan approved by the Board; and (f) lease consistent with the applicable Board-approved budget. Leases that fall outside of these parameters are presented to the Board for approval.

For FY19-20, the Board-approved budget for capital expenditures is an additional \$10.5 million to supplement the originally approved \$25.0 million for a total tenant improvement and base building budget of \$35.5 million. This assumes the remaining approximately 36,000 square feet of approximately 92,000 square feet of commercial/retail space construction, would be fully leased by fiscal year end. The average contribution from the TJPA of \$113 per square foot in tenant improvement allowance ranging from \$50 per square foot to \$300 per square foot depending on the type of space from personal service business to full service restaurant (note that the TJPA does not expect that each tenant would be entitled to the budgeted level of contribution; the TJPA team intends to vigorously negotiate the agency's contribution, if any, toward a tenant's improvements and would expect greater rent as a result of any contribution the TJPA makes to the cost of tenant improvements). The average base building budget is \$171 per square foot. Base building work includes topping slab, mechanical, electrical, plumbing and fire life safety installations. This amount will fluctuate on a per space basis.

In FY17-18, Colliers developed a multi-year projected schedule for each space -- in other words, a projection (pro forma) that outlines the targeted or market rent, the percentage increases for each year, the number of years in the term and the tenant improvement allowance. The pro forma is individualized for each space because the pro forma is influenced by the type of space and its location within the center. Under the schedule, stabilized first year rents total approximately \$6.40 million annually which compares favorably with Lincoln's initial projected, stabilized rents of about \$5.51 million annually. This pro forma continues to be mostly adhered to.

As such, each proposed deal takes into consideration the approved budget for capital expenditures, the projected rent schedule, and adherence to the Plan as key factors in determining whether to proceed with a proposed tenant.

#### Proposed Commercial/Retail Leasing Transaction – Spring Fertility Management LLC

The following summarizes the key business terms of a proposed commercial/retail lease with Spring Fertility Management, LLC.

<b>Prospective Tenant Name</b>	<b>Suite #</b>	<b>Premises Area (sq ft)</b>	<b>Category</b>	<b>Stated Base Rent (over Initial Term) 1, 2</b>	<b>Initial Term (years)<sup>3</sup></b>	<b>TI Allowance</b>	<b>Base Building Estimate</b>
Spring Fertility Management LLC	222 & 224	2,541	Service	\$3,308,188.81 (avg ~\$86.79 psf per year)	15 years	\$127,050 (\$50.00 psf)	\$481,429
Notes: 1. Market conditions call for rent to be on a “gross” basis which means that common area expenses are imbedded in the rent. 2. Reflects annual rent increases at 3% per year. 3. Two 5-year options to renew.							

The business terms are more favorable than proforma as follows. The ten year proforma rent is \$1,747,783 whereas the deal rent at ten years is \$2,039,080--a positive difference of \$291,297. This deal is for 15 years for a total rent of \$3,308,189—a positive difference from proforma of \$1,560,406. The tenant improvement proforma allowance is \$50/psf as is the deal allowance. The base building improvement proforma budget was \$692,587 and the deal estimate is \$481,429, as such a positive difference of \$211,158. This results in net proceeds on the 10 year deal of \$1,430,601 as compared to the 10 year proforma of \$927,692—a positive difference of \$502,909. On the 15 year deal, rent less base building improvements and tenant improvement allowance results in net proceeds of \$2,699,710.

<b>Pro forma</b>			
<b>Base Rent Over Initial Term</b>	<b>Initial Term</b>	<b>TI Allowance</b>	<b>Base Building Estimate</b>
\$1,747,783.04 <sup>1, 2</sup> (avg ~\$68.78 psf per year)	10	\$127,050 (\$50.00)	\$692,587
1. Assumed 3% annual increases. 2. The pro forma rent is stated as “gross”.			

Lastly, signed lease transactions to date—including both 10-year through 15-year leases—produces a positive cashflow of \$48,716,306. For comparison purposes, a 10-year scenario (which also includes this transaction) produces a positive cash flow of \$30,401,136. Please refer to the attached Lease Analysis Summary for further detail.

Spring Fertility Management is a fertility services provider with three other Bay Area locations (East Bay, Silicon Valley and San Francisco Headquarters). This location is an expansion satellite office that will primarily be used for patient consultation and information sessions. The only onsite medical activity will be blood draws.

A lease with Spring Fertility Management is a favorable transaction for the transit center. It adheres to the Plan’s expectation that this portion of the second level would focus on personal service businesses—in particular since it is immediately adjacent to Onsite Dental. It exceeds the initial FY17-18 proforma for rental revenue. It is within the budgeted tenant improvement allowance and the budgeted base building improvements for the premises. And, its financial

strength has been validated by Lincoln through a review of financial information and bank statements.

Upon full execution of the lease, construction is expected to be completed in six to seven months taking into consideration design and permitting.

As of the date of this report, the tenant is fully committed to moving forward by having signed a letter of intent wherein all the material terms and conditions have been negotiated and agreed to. The lease form has been thoroughly reviewed, of which a draft is attached. It is generally consistent with the TJPA Board approved template.

In that the initial term and rent are both greater than the Policy threshold of ten years and \$1.8 million respectively, the proposed lease transaction is being submitted to the TJPA Board for its approval.

**RECOMMENDATION:**

Authorize the Executive Director to complete negotiations and execute a lease agreement with Spring Fertility Management LLC consistent with the key business terms outlined herein and based on the attached agreement (which is based on the lease template attached to the Policy) but subject to modifications as he finds reasonable, prudent and consistent with the TJPA's obligations.

**ENCLOSURES:**

1. Resolution
2. Spring Fertility Management LLC lease (draft)
3. Lease Analysis Summary

**TRANSBAY JOINT POWERS AUTHORITY  
BOARD OF DIRECTORS**

**Resolution No. \_\_\_\_\_**

WHEREAS, The Transbay Joint Powers Authority (TJPA) is a joint powers agency organized and existing under the laws of the State of California to design, build, and operate the Transbay Transit Center Program (Transbay Program); and

WHEREAS, The TJPA's construction of the new transit center is nearing completion and the TJPA is activating one of the elements of the Transbay Program—approximately 100,000 square feet of commercial/retail areas located on the ground, second, and park levels; and

WHEREAS, In March 2017 the TJPA Board authorized an Asset Management Agreement with a team led by Lincoln Property Company (Lincoln) for the transit center. Lincoln and its team member Colliers International are managing the commercial/retail leasing of the transit center; and

WHEREAS, In July 2017 the TJPA Board approved a Retail Merchandising Plan (Plan), and authorized the team to begin marketing and negotiations for retail leasing generally consistent with the Plan; and

WHEREAS, In October 2017 the TJPA Board approved a Retail Leasing Policy authorizing the Executive Director to execute leases that meet certain criteria; and

WHEREAS, On TJPA's behalf, the Lincoln team is negotiating lease terms with Spring Fertility Management for commercial/retail space on the second floor of the transit center; and

WHEREAS, The lease terms are consistent with the Plan; and

WHEREAS, A lease with Spring Fertility Management LLC would be a favorable transaction for the transit center. It adheres to the Plan's expectation that this portion of the second floor would focus on personal service businesses; it exceeds the initial Fiscal Year 2017-18 pro forma for net rental revenues at the premises; Spring Fertility Management LLC is an established, financially sound business in the bay area; now, therefore, be it

RESOLVED, That the TJPA Board authorizes the Executive Director to complete negotiations and execute a lease agreement with Spring Fertility Management LLC, for certain commercial space in the transit center, consistent with the key business terms outlined in the report to the Board, and based on the form of lease agreement presented to the Board but subject to modifications as the Executive Director finds reasonable, prudent and consistent with the TJPA's obligations; and, be it

FURTHER RESOLVED, That the TJPA Board authorizes the Executive Director to take all actions and execute all documents as he deems reasonably necessary to implement and effectuate the above approval.

I hereby certify that the foregoing resolution was adopted by the Transbay Joint Powers Authority Board of Directors at its meeting of November 14, 2019.

\_\_\_\_\_  
Secretary, Transbay Joint Powers Authority

**SALESFORCE TRANSIT CENTER  
LEASE**

Landlord:

TRANSBAY JOINT POWERS AUTHORITY,  
a joint exercise of powers agency duly created and existing under  
the Joint Exercise of Powers Act of the State of California,  
California Government Code Sections 6500 et seq.

and

Tenant:

Spring Fertility Management, LLC  
a \_\_\_\_\_

**SALESFORCE TRANSIT CENTER**

**LEASE**

**Table of Contents**

	<u>Page Reference</u>
Article 1 – Premises, Center, Term and Use.....	4
Article 2 – Rent.....	7
Article 3 – Security Deposit.....	10
Article 4 – Taxes and Assessments and Liens .....	10
Article 5 – Security .....	11
Article 6 – Utility Services .....	12
Article 7 – Additional Construction.....	13
Article 8 – Subordination and Attornment.....	13
Article 9 – Repairs and Maintenance.....	14
Article 10 – Alterations.....	15
Article 11 – Fixtures and Personal Property .....	16
Article 12 – Compliance with Laws .....	17
Article 13 – Insurance.....	18
Article 14 – Indemnification and Waiver .....	18
Article 15 – Damage and Destruction.....	19
Article 16 – Eminent Domain.....	20
Article 17 – Assignment and Subletting .....	21
Article 18 – Access to Premises.....	23
Article 19 – Defaults by Tenant.....	23
Article 20 – Surrender of Premises .....	26
Article 21 – Tenant’s Conduct of Business; Operational Requirements; Center Operations.....	26
Article 22 – Signage.....	28
Article 23 – Holding Over .....	29
Article 24 – Estoppels.....	29
Article 25 – Financial Statements.....	29
Article 26 – Miscellaneous Provisions .....	29

EXHIBIT A	SITE PLAN OF PREMISES
EXHIBIT B	WORK LETTER
EXHIBIT C	INSURANCE
EXHIBIT D	RULES AND REGULATIONS
EXHIBIT E	NAMING RIGHTS REQUIREMENTS
EXHIBIT F	GOVERNMENTAL REQUIREMENTS
EXHIBIT G	FORM OF COMMENCEMENT DATE CERTIFICATE
EXHIBIT H	LIST OF USE RESTRICTIONS
EXHIBIT I	RADIUS
EXHIBIT J	FORM OF GUARANTY
EXHIBIT K	SIGNAGE

ADDENDUM TO LEASE – OPTION TO EXTEND TERM

**SALESFORCE TRANSIT CENTER**

**LEASE**

THIS LEASE (“**Lease**”) is entered into by and between the landlord and tenant specified in the Basic Lease Information (hereinafter “**Landlord**” and “**Tenant**”, respectively) as of the date (“**Lease Date**”) specified in the Basic Lease Information.

**BASIC LEASE INFORMATION**

Date: October \_\_, 2019.

Landlord: TRANSBAY JOINT POWERS AUTHORITY, a joint exercise of powers agency duly created and existing under the Joint Exercise of Powers Act of the State of California, California Government Code Sections 6500 et seq.

Tenant: Spring Fertility Management LLC

Tenant’s Trade Name: Spring Fertility

Center: Salesforce Transit Center, located at First and Mission Streets in San Francisco, California.

Premises: Retail spaces identified as Space Numbers 222 and 224, located in the retail usage area on the second level of the Center, in the location generally depicted on the Site Plan attached as Exhibit A.

Floor Area of Premises: Two thousand five hundred forty-one (2,541) useable square feet

Commencement Date: The earlier of (a) the date on which Tenant first opens for business in the Premises and (b) the date that is ninety (90) days after the date on which Landlord delivers possession of the Premises to Tenant with the Landlord Work (as defined in the Work Letter attached as Exhibit B) Substantially Completed (as defined in the Work Letter attached as Exhibit B).

Expiration Date: The last day of the one hundred twentieth (180<sup>th</sup>) month following the month in which the Commencement Date occurs.

Permitted Use: The Premises shall be used for the exclusive purpose of a medical fertility clinic satellite office providing patient consults, informational sessions, monitoring and phlebotomy services directly related to fertility and fertility preservation services.

Base Rent:

<u>Months</u>	<u>Annual Rate per Useable Square Foot</u>	<u>Monthly Installment of Base Rent</u>	<u>Annual Base Rent</u>
1 - 12	\$70.00	\$14,822.50	\$177,870.00



13-24	\$72.10	\$15,267.18	\$183,206.10
25-36	\$74.26	\$15,725.19	\$188,702.28
37-48	\$76.49	\$16,196.95	\$194,363.35
49-60	\$78.79	\$16,682.85	\$200,194.25
61-72	\$81.15	\$17,183.34	\$206,200.08
73-84	\$83.58	\$17,698.84	\$212,386.08
85-96	\$86.09	\$18,229.81	\$218,757.66
97-108	\$88.67	\$18,776.70	\$225,320.39
109-120	\$91.33	\$19,340.00	\$232,080.01
121-132	\$94.07	\$19,920.20	\$239,042.21
133-144	\$96.90	\$20,517.81	\$246,213.68
145-156	\$99.80	\$21,133.34	\$253,600.09
157-168	\$102.80	\$21,767.34	\$261,208.09
169-180	\$105.88	\$22,420.36	\$269,044.33

Percentage Rate: N/A

Tenant's Address for Notices: \_\_\_\_\_  
 \_\_\_\_\_  
 \_\_\_\_\_

Telephone \_\_\_\_\_  
 Email \_\_\_\_\_

Landlord's Address for Notices: Transbay Joint Powers Authority  
425 Mission Street, Suite 250  
San Francisco, CA 94105  
Attn: Facility Manager  
Facsimile: (415) 597-4615

with a copy to:

LPC West Transit Management LLC  
915 Wilshire Boulevard, Suite 1950  
Los Angeles, CA 90017  
Attention: Ginger Dunbar  
Facsimile: (213) 542-8241  
E-mail: GDunbar@LPC.com

Landlord's Address For Rent Payments: Payments are to be made to Transbay Joint Powers Authority at an address to be designated by Landlord.

Landlord's Broker: Colliers International

Tenant's Broker: Compass Commercial

Deposit: [Waiting for Landlord to determine]

Interest Rate: The lesser of (i) four percent (4%) per annum above the then-current "prime rate" or "reference rate" charged by Bank of America (or such reasonable comparable national banking institution as selected by Landlord in the event Bank of America ceases to exist or publish a "prime rate" or "reference rate"), or (ii) the maximum rate permitted by applicable law.

Guarantors: James Deng, an individual

Radius: The area depicted in Exhibit I attached hereto.

Minimum Required Hours: Monday – Friday: a.m. to p.m.  
Saturday: a.m. to p.m.  
Sunday: a.m. to p.m.

In the event of any conflict between this Basic Lease Information and the other terms of this Lease, the other terms of this Lease shall control.

#### Article 1 – Premises, Center, Term and Use

(a) Premises.

(i) Landlord leases to Tenant and Tenant leases from Landlord the premises (the "**Premises**") shown as shaded area on the site plan ("**Site Plan**") attached hereto and incorporated herein by reference as Exhibit A, which Premises are located in the retail usage portion of the Salesforce Transit Center located at First and Mission Streets in San Francisco, California (the "**Center**"). The Site Plan is for informational purposes only and is not a warranty, representation or agreement on the part of Landlord that the Center will be exactly as indicated on such exhibit, will be continuously occupied throughout the Term (as hereinafter defined), or that the other tenants or occupants of the Center, if any, which now

occupy space in the Center will remain occupants of the Center throughout the Term. As of the date on which Landlord delivers the Premises to Tenant, the Premises (including any Building Systems (as defined in Section 9(a) below) serving the same) shall be in good operating order and condition, without taking into account the effect thereon of any alterations or other modifications to the Premises by Tenant or its agents, employees or contractors. In the event that the Premises are not delivered in the foregoing condition and such failure is not caused by Tenant (including, but not limited to, any alterations or other modifications to the Premises by Tenant or its agents, employees or contractors), then it shall be the obligation of Landlord, and the sole right and remedy of Tenant, after receipt of written notice from Tenant setting forth with specificity the nature of the failed performance, to promptly, within a reasonable time and at Landlord's sole cost, correct such failure. Except as specifically provided in this Lease, the Premises shall be delivered to Tenant in its "as is, where is, with all faults" condition and Landlord expressly disclaims any representation or warranty concerning the condition thereof. Without limiting the foregoing, except as specifically provided in this Lease, Landlord has made no representation or warranty as to the use, habitability, merchantability, fitness, suitability, value or adequacy of the Premises for any particular purpose or as to pedestrian traffic, profitability or views of the Center or the Premises.

(ii) The Floor Area of the Premises is agreed to be the number of useable square feet specified in the Basic Lease Information. Any statement of useable square footage set forth in this Lease, or that may have been used in calculating any of the economic terms hereof, is an approximation which Landlord and Tenant agree is reasonable and no economic terms based thereon shall be subject to revision whether or not the actual useable square footage is more or less.

(iii) Landlord shall have the right, upon one hundred twenty (120) days' notice to Tenant (the "**Relocation Notice**"), to relocate Tenant to other premises of comparable size and visibility as the Premises (the "**Substitution Space**") within the retail usage area of the Center. Landlord shall, at Landlord's cost, perform all work necessary to cause the Substitution Space to be in a condition reasonably comparable to the Premises, provided, however, that Landlord shall be entitled to remove all Improvements (as defined in Article 10 below) which may be economically removed from the Premises and replace them within the Substitution Space as part of such work. In addition, Landlord shall reimburse Tenant for Tenant's reasonable out of pocket costs of moving any personal property of Tenant at the Premises not moved from the Premises to the Substitution Space by Landlord. In the event Landlord exercises such relocation right, Tenant and Landlord shall amend this Lease to provide for (A) the substitution of the Substitution Space for all references to the Premises contained herein, and (B) a Base Rent equal to the Base Rent per usable square foot payable by Tenant under this Lease multiplied by the number of usable square feet in the Substitution Space. In all other respects, the terms and conditions contained in this Lease shall remain unmodified and in full force and effect. Tenant shall move to the Substitution Space and reopen therein for business with the public within ten (10) days of delivery of the same by Landlord in the condition required hereunder and shall surrender the Premises to Landlord at the end of such ten (10) day period. Notwithstanding the foregoing, if Landlord delivers a Relocation Notice to Tenant and such relocation and/or the proposed Substitution Space are unacceptable to Tenant for any reason, Tenant shall have the right, as its sole and exclusive remedy, upon notice to Landlord to be given within thirty (30) days after the Relocation Notice, to terminate this Lease effective thirty (30) days after Tenant's termination notice.

(b) Common Areas.

(i) During the Term, Tenant is granted the non-exclusive right to use all areas and facilities located within the Center that are designated by Landlord from time to time for the general use and convenience of retail tenants of the Center, transit passengers, and other visitors to the Center (collectively, the "**Common Area**"), subject to the Tenant Rules and Regulations (as defined in Section 21(b)(i) below); provided, however, that Tenant's exercise of such right shall not impede or interfere unduly with the operations at the Center by Landlord, its tenants, customers, and other authorized occupants (including, without limitation, any transit agency or rail operator).

(ii) The Center and the Common Areas shall be subject to the exclusive management and control of Landlord. Landlord shall have the right from time to time and without affecting Tenant's obligations under this Lease to (A) designate, relocate and limit the use of particular areas or portions of the Common Areas, (B) to add to and delete areas therefrom, (C) to temporarily close off portions of the Center, including any Common Area, (D) to adjust passenger circulation flows and issues related thereto, and (E) to establish, promulgate, amend and enforce such reasonable and non-discriminatory rules and regulations concerning the Common Areas as it may reasonably deem necessary or advisable for the proper and efficient management, operation, maintenance and use thereof, and Tenant shall comply with the same. In the exercise of Landlord's rights under this Section 1(b)(ii), except in the event of an emergency or in the case of any action taken to avoid a condemnation of any portion of the Center, Landlord shall not unreasonably impair the visibility of Tenant's Premises in any material respect or unreasonably interfere with Tenant's access, ingress and egress to and from the Premises in any material respect.

(c) Term.

(i) This Lease shall be effective as of the date of execution by all parties hereto and the term of this Lease (the "**Term**") shall commence upon the Commencement Date set forth in the Basic Lease Information and shall end on the Expiration Date specified in the Basic Lease Information, unless extended or sooner terminated as set forth herein. As soon as the Commencement Date has been determined, the parties shall execute a supplemental instrument in the form of Exhibit G attached hereto memorializing the Commencement Date and the Expiration Date.

(ii) If Landlord is delayed in delivering possession of the Premises to Tenant due to the holding over of an existing tenant of the Center, or for any reason other than Landlord's willful refusal to deliver the Premises when Landlord is otherwise reasonably capable of such delivery, then Landlord shall not be subject to any liability whatsoever to Tenant for such delay, and such failure shall not impair the validity of this Lease or the obligations of Tenant hereunder. Notwithstanding anything to the contrary contained herein, Landlord has no obligation to deliver possession of the Premises to Tenant until Tenant has delivered (A) the Deposit required pursuant to Article 3 below and the Guaranty executed by Guarantor, (B) the Advance Rent set forth in the Basic Lease Information, and (c) the insurance certificates evidencing that Tenant carries the coverage specified in the Insurance Requirements attached as Exhibit C (collectively, the "**Delivery Requirements**"). Tenant's failure to satisfy the Delivery Requirements shall not delay the Commencement Date.

(iii) Upon the mutual execution and delivery of this Lease and provided that Tenant has satisfied the Delivery Requirements, Tenant shall have the right to enter the Premises during the Center's normal business hours for the limited purposes of site assessment, taking measurements and determining existing conditions; provided that, in the course of any such entry, Tenant and its representatives, employees, agents, consultants and contractors shall not interfere with Landlord or Landlord's contractor in completing the Center. Tenant shall provide Landlord with at least forty-eight (48) hours prior notice of such entry, which notice shall include a schedule detailing the timing and specific purpose of Tenant's entry for Landlord's approval. Such entry shall be subject to all terms and provisions of this Lease other than the provisions requiring the payment of Base Rent.

(iv) [Intentionally deleted]

(d) Use.

(i) The Premises shall be used and occupied only for the Permitted Use and under the trade name specified in the Basic Lease Information and for no other purpose and under no other trade name whatsoever. Tenant shall operate its business at the Premises at all times in a first class manner so as to maximize revenues. Landlord or Landlord's agents shall have the right to inspect the Premises

during business hours to verify that the Premises are in compliance with the Permitted Use and, in the event that Landlord, in Landlord's sole discretion, determines that Tenant's business is being operated in violation of the Permitted Use, Landlord shall notify Tenant, specifying the nature of the violations and a detailed description of what Tenant is required to do to cure the violation. Tenant shall cure such violation within twenty-four (24) hours after receipt of the notice from Landlord. If Tenant does not cure such violation in accordance with Landlord's notice within such 24-hour period, such failure shall constitute an Event of Default and, in addition to any other rights and remedies that Landlord may have as a result of such Event of Default under this Agreement, at law or in equity, Landlord shall have the right to provide a second notice of such violation to Tenant and if Tenant still fails to cure such violation within twenty-four (24) hours after receipt of such second notice from Landlord, Landlord may require Tenant to pay to Landlord upon demand One Thousand Dollars (\$1,000.00) for each day such violation continues thereafter. Tenant acknowledges that failure to strictly comply with the requirements of this Section 1(d) will have a significant effect on the image and reputation of the Center, negatively impact the experience of patrons shopping at the Center, thereby decreasing traffic in the Center and decreasing overall sales volume of the tenants in the Center. The exact amount of the damages caused by Tenant's failure to comply with the provisions of this Section 1(d)(i) are extremely difficult and impracticable to fix, therefore, the parties agree that the above-described sums represent fair and reasonable estimates of such damages. Receipt by Landlord of the sums hereunder shall not be Landlord's exclusive remedy in the event of Tenant's violation of this Section 1(d)(i) and shall not preclude Landlord from exercising any other rights which it may have at law, in equity or under the terms of this Lease as a result of such a breach by Tenant. Tenant's covenants under this Section 1(d)(i) constitute material consideration for Landlord's entering into this Lease.

(ii) Tenant acknowledges and agrees that Tenant has no exclusive rights to conduct the business of the Permitted Use and that Landlord may arrange with others for similar activities at the Center.

(iii) If during the Term: (A) Tenant, its parent, subsidiary, franchisor, or franchisee, or the Guarantor of this Lease, if any; (B) any person, firm, corporation or other entity having an interest in any of the foregoing parties; or (C) any other person, firm or corporation controlling or controlled by Tenant or any of the foregoing parties, shall directly or indirectly, either individually or as a partner, shareholder, agent, employee or otherwise, own, operate, maintain or have an affiliation, investment or interest in business similar to or in competition with the one operated at the Premises that is operated under the same trade name within the Radius specified in the Basic Lease Summary as measured from the perimeter of the Center (except those carried on as of the Commencement Date or departments or concessions or the like within anchor or department stores) then such action shall constitute an Event of Default under this Lease. At Landlord's option, in addition to Landlord's other remedies, the Gross Sales (as defined in Section 2(c)(iv) below) from any other business within the specified Radius shall be included in the Gross Sales of the Premises during each year. Tenant shall submit monthly sales statements and maintain records of the sales and transactions of the other business. A substantial increase in size or other substantial change in the business at locations in existence on the Commencement Date, or change in location to a location within the Radius, shall remove the exemption created for that location.

(e) Patio Area. [Intentionally deleted]

## Article 2– Rent

(a) Rent. Commencing on the Commencement Date, Tenant shall pay to Landlord as “**Rent**” hereunder, without demand, credit, offset or deduction, the Base Rent, the Percentage Rent, and any Additional Rent due hereunder. All Rent and other sums due hereunder shall be paid or mailed to Landlord's address for rental payments set forth in the Basic Lease Information or to such other payee or address as Landlord may designate, in writing, to Tenant. No Rent or other sums due hereunder shall be deemed paid until actually received by Landlord.

(b) Base Rent.

(i) Commencing on the Commencement Date, Tenant shall pay as rental for the use and occupancy of the Premises, at all times and in the manner herein provided, the Base Rent set forth in the Basic Lease Information. The Base Rent shall be payable in monthly installments, in advance, upon the first day of each month during the Term, commencing on the Commencement Date. If the Commencement Date is a day other than the first day of a month, then the monthly installment of the Base Rent for the period from the Commencement Date until the first day of the month next following shall be prorated, at the rate of one-thirtieth (1/30th) of such monthly installment per day, and paid on the Commencement Date.

(ii) Upon execution of this Lease, Tenant shall pay to Landlord the sum specified in the Basic Lease Information as “**Advance Rent**”. The Advance Rent shall be applied to Tenant’s obligation to pay the Base Rent for the first month or months for which the Base Rent is due. If Tenant fails to pay the Advance Rent within five (5) business days after delivery of the fully-executed Lease by Landlord to Tenant, then Landlord may terminate this Lease by written notice to Tenant at any time prior to Tenant’s actual payment of the Advance Rent to Landlord.

(c) Percentage Rent

(i) In addition to the payment of Base Rent, Tenant shall pay to Landlord “**Percentage Rent**” at the times and in the manner hereinafter. Percentage Rent for each calendar year (or portion thereof) during the Term shall be calculated by determining the amount by which Gross Sales for such calendar year exceed, if at all, the Breakpoint (as hereinafter defined) for such calendar year and multiplying the difference by the Percentage Rate set forth in the Basic Lease Information. The “**Breakpoint**” for each calendar year is an amount equal to the annual Base Rent for such calendar year (reduced by any rental abatement) divided by the Percentage Rate. The Breakpoint for any partial year shall be pro-rated based upon a 365-day year.

(ii) Percentage Rent is due for each calendar quarter during the Term, beginning in the second (2<sup>nd</sup>) lease year, within ten (10) days after the end of the first (1st) calendar quarter that Gross Sales for the applicable calendar year have reached the Breakpoint for such calendar year, and each quarter thereafter during such calendar year.

(iii) Tenant acknowledges that Percentage Rent is anticipated to be a significant portion of the Rent over the duration of the Term. Accordingly, Tenant agrees that if in any calendar year Tenant fails to conduct its business in the entire Premises in the manner and on each day as required under the terms of this Lease, then, for the purpose of computing Percentage Rent for such calendar year, the Breakpoint for such calendar year shall be adjusted by multiplying the Breakpoint otherwise applicable by a fraction, the numerator of which shall be the actual number of days throughout which Tenant conducts its business in the entire Premises in such calendar year as required under the terms of this Lease and the denominator of which shall be the total number of days during which Tenant is obligated to conduct its business in the entire Premises in such calendar year as required under the terms of this Lease.

(iv) The term “**Gross Sales**” as used herein shall mean the sum of the entire amount of the actual sales price, whether for cash or otherwise, of all sales of all food, beverages, merchandise and services sold at the Premises, the entire amount of the rental or other charges for all items leased or rented at the Premises, and all other receipts whatsoever of all business conducted on or from the Premises by Tenant, its sublessees, concessionaires or licensees or any party claiming by or through any of them. Gross Sales includes, without limitation, (A) mail, catalog, telephone, internet or other remote orders made, received or filled at or from the Premises, or credited or attributable to the Premises, (B) all deposits not refunded to purchasers, (C) orders taken in, on or from the Premises although said orders

may be filled elsewhere, (D) advance sales and sales of gift certificates, vouchers and the like at the Premises, (E) sales for credit, (F) merchandise or services exchanged for other merchandise or services (unless previously included in Gross Sales), and (G) sales by any sublessee, concessionaire or licensee or any other person or entity in, on or from the Premises. Each lease or rental of merchandise shall be treated as a sale in the month during which such lease or rental is made, for a price equal to the total rental payable. The only exclusions from Gross Sales are (1) sums collected and paid out by Tenant for sales or excise tax imposed by any duly constituted United States, California or local government authority where such taxes are both added to the selling price (or absorbed therein) and paid to the taxing authorities by Tenant (but not by any vendor of Tenant), (2) sums collected by Tenant and paid out by Tenant for postage, delivery and handling of merchandise, (3) the exchange or transfer of merchandise between stores of Tenant or its affiliates, if any, where such exchange or transfer of goods or merchandise is not made for the purpose of depriving Landlord of the benefit of a sale that otherwise would be made in, on or from the Premises, (4) the amount of returns to shippers or manufacturers or other sources, (5) proceeds from the sale of used trade fixtures, equipment or property which are not stock in trade, (6) the amount of any cash or credit refund or adjustment made upon any sale in, on or from the Premises where the merchandise sold, or some part thereof, is thereafter returned by the purchaser and accepted by Tenant or otherwise voided sales, (7) proceeds from sales to employees of Tenant at discounts of twenty percent (20%) or more of retail price, not to exceed two percent (2%) of Gross Sales, and (8) alteration charges.

(v) Tenant shall furnish to Landlord within ten (10) days after the end of each calendar month of the Term a written statement of Gross Sales covering the immediately preceding calendar month, which statement shall contain such details and breakdown as Landlord may reasonably require. In addition, Tenant shall furnish to Landlord within twenty (20) days after expiration of each calendar year, a complete and correct statement, showing in reasonable detail the amount of Gross Sales made at or from the Premises during the preceding calendar year or partial calendar year (the “**Annual Statement**”). Each Annual Statement shall be certified as accurate by a financial officer of Tenant or, if available, an independent certified public accountant.

(vi) For a period of five (5) years after the Expiration Date (or, in the event of a claim by Landlord, until such claim for payments hereunder have been fully ascertained, fixed, and paid), Tenant shall keep full and accurate books and records of all transactions from the Premises in accordance with generally accepted accounting principles in the United States consistently applied. Tenant shall require each subtenant, concessionaire, licensee, and assignee to maintain the same records. Landlord shall have the right, from time to time, to audit Tenant's records and books in order to verify Tenant's Gross Sales and exclusions from Gross Sales (an “**Audit**”). During the Term and for a period of five (5) years after the Expiration Date, Tenant shall make all such books and records available for the Audit at the Premises or at Tenant's offices in the State of California. Upon request by Landlord, Tenant shall authorize the California Board of Equalization or successor governmental entity to release to Landlord copies of all returns filed by Tenant with such entity pertaining solely to Tenant's operation of business in and from the Premises or pertaining to the operation of any business, the sales of which are included in Gross Sales under the provisions of this Lease, or shall take such other action as necessary to cause such release. If the Audit discloses an underpayment of Percentage Rent, Tenant shall immediately pay to Landlord the amount of the underpayment, with interest at the Interest Rate set forth in the Basic Lease Summary from the date the payment should have been made. If the Audit discloses an underreporting of Gross Sales in excess of two percent (2%) of the reported Gross Sales, and additional Percentage Rent is due, then Tenant shall also pay to Landlord the cost of the Audit and collection of the underpayment, including reasonable attorneys' fees. If the Audit discloses an overpayment of Percentage Rent, Tenant may offset the excess against its next payment(s) of Rent other than Base Rent. The acceptance by Landlord of Percentage Rent payments shall be without prejudice to Landlord's right to verify the amount of annual Gross Sales made at or from the Premises and to make appropriate adjustments in amounts due.

(d) Additional Rent. All sums required to be paid by Tenant to Landlord hereunder in addition to Base Rent and Percentage Rent whether or not such sums are designated as “Rent” shall be

herein collectively referred to as “**Additional Rent**”. Landlord shall have the same remedies for a default in the payment of any such Additional Rent as for a default in the payment of Base Rent or Percentage Rent.

(e) Guaranty. This Lease and Tenant’s performance of all of its promises, covenants, agreements, and obligations hereunder is guaranteed by the Guarantor, regardless of whether Tenant’s leasehold interest is assigned or otherwise transferred by Tenant or its transferee. In connection with Tenant’s execution and delivery of the Lease, Tenant has caused the Guarantor to concurrently deliver a signed Guaranty in the form attached hereto as Exhibit J (the “**Guaranty**”).

### Article 3 – Security Deposit

Tenant shall deposit with Landlord the sum indicated under “Deposit” in the Basic Lease Information within one (1) business day after delivery of the fully-executed Lease by Landlord to Tenant (the “**Deposit**”). If Tenant fails to pay the Deposit within five (5) business days after delivery of the fully-executed Lease by Landlord to Tenant, then Landlord may terminate this Lease by written notice to Tenant at any time prior to Tenant’s actual deposit of the Deposit with Landlord. The Deposit shall be held by Landlord as security for the faithful performance by Tenant of all of the terms, covenants and conditions of this Lease. The Deposit shall not be mortgaged, assigned, transferred or encumbered by Tenant without the prior written consent of Landlord and any such act on the part of Tenant shall be without force and effect and shall not be binding upon Landlord. Landlord shall be entitled to commingle the Deposit with Landlord’s other funds and Tenant shall not be entitled to any interest thereon. If any of the Rent herein reserved or any other sum payable by Tenant to Landlord is overdue and unpaid, or if Landlord makes any payments on behalf of Tenant, or if Tenant fails to perform any of its obligations under this Lease, then Landlord may, at its option and without prejudice to any other remedy which Landlord may have on account thereof, apply the entire Deposit, or so much thereof as may be necessary, to the payment of such sums or to reimburse Landlord for loss or damage sustained by Landlord due to a breach on the part of Tenant, and Tenant shall promptly upon demand pay an amount sufficient to restore the Deposit to the original sum deposited. Landlord may deliver the Deposit to the transferee of Landlord’s interest in the Premises and, upon notice thereof by Landlord to Tenant, Landlord shall be discharged from any further liability with respect to such funds. If Tenant performs all of its promises, covenants, agreements, and obligations under this Lease, the Deposit or any remaining balance shall be returned to Tenant (or, at Landlord’s option, to the last assignee, if any, of Tenant’s interest hereunder) within sixty (60) days after the Expiration Date or earlier termination of this Lease, and after Tenant has vacated the Premises and surrendered possession. No trust relationship is created herein between Landlord and Tenant with respect to the Deposit or any proceeds thereof. Tenant hereby waives the provisions of Section 1950.7 of the California Civil Code and all other provisions of law, now or hereafter in effect, which (a) establish the time frame by which a Landlord must refund a security deposit under a lease, and/or (b) provide that a Landlord may claim from a security deposit only those sums reasonably necessary to remedy defaults in the payment of rent, to repair damage caused by a Tenant or to clean the premises, it being agreed that Landlord may, in addition, claim those sums specified in this Article 3 and/or those sums reasonably necessary to compensate Landlord for any loss or damage caused by Tenant’s breach of this Lease, including any damages Landlord suffers following termination of this Lease.

### Article 4– Taxes and Assessments and Liens

(a) Taxes and Assessments.

(i) Tenant recognizes and understands that this Lease may create a possessory interest subject to property taxation and that Tenant may be subject to the payment of property taxes levied on such interest. Tenant agrees to pay taxes of any kind, including any possessory interest taxes,



that may be lawfully assessed on the leasehold interest hereby created and to pay all other taxes, excises, licenses, permit charges and assessments based on Tenant's usage of the Premises that may be imposed upon Tenant by law, all of which shall be paid when the same become due and payable and before delinquency.

(ii) Tenant shall pay before delinquency all taxes or other impositions levied or assessed upon its trade fixtures, improvements, merchandise, furniture, equipment and other personal property in, on or upon the Premises at least ten (10) days prior to delinquency, and shall deliver satisfactory evidence of such payment to Landlord. If any such items of property are assessed with property of Landlord, then such assessment shall be equitably divided by Landlord so that Tenant pays Tenant's equitable portion of such assessment. Landlord's reasonable proration of any such assessments shall be binding upon Tenant.

(b) Liens. Tenant shall not permit or suffer any liens to be imposed upon the Premises, the Center or upon any equipment or property located thereon, including, without limitation, mechanics', materialmen's and tax liens, as a result of Tenant's or any of Tenant's principals, affiliates, contractors, employees, agents, licensees, guests or invitees activities without promptly discharging the same. Tenant shall, within ten (10) days after becoming aware of the filing of any such lien, cause the same to be discharged of record by payment, deposit, or bond in the amount required by a court of competent jurisdiction. If Tenant fails to cause any such lien to be so discharged, then Landlord, in addition to any other rights or remedies, may, but shall not be obligated to, upon five (5) days' notice to Tenant, discharge the same by paying the amount claimed to be due or by procuring the discharge of such lien by deposit or by bonding proceedings and in any such event, Landlord shall be entitled, if Landlord so elects, to defend any such prosecution of an action for foreclosure of such lien by the lienor and to pay the amount of any judgment in favor of such lienor (plus interest, costs and allowances). Any amount paid by Landlord together with interest thereon at the Interest Rate and all costs and expenses, including reasonable attorneys' fees incurred by Landlord in connection therewith, shall be paid by Tenant to Landlord on demand. Tenant's obligation to observe and perform any of the provisions of this Section 4(b) shall survive the expiration of the Term or the earlier termination of this Lease. Notwithstanding the foregoing, Tenant may in good faith contest any such lien if Tenant provides a bond in an amount and form acceptable to Landlord in order to clear the record of any such liens.

#### Article 5 – Security

(a) Center Security. Tenant acknowledges that Landlord has contracted directly with a third party security provider (the "**Security Contractor**") to provide security service to the Center, excluding the Premises and any other premises within the Center that are leased to tenants or other occupants of the Center. The Security Contractor provides security at locations and levels determined appropriate by Landlord, in its sole discretion. Tenant acknowledges that in order to maintain safety and security to the Center, Landlord retains the right to install safety and security systems and devices, and promulgate and enforce such procedures and regulations as may be deemed necessary or desirable by Landlord in its sole discretion, which may include the establishment of Center security procedures such as background checks and appropriate Government security clearance and the distribution to certain of Tenant's employees of photo identification cards and requiring the presentation of such photo identification cards in order to gain access to certain portions of the Center.

(b) Tenant's Obligations. Tenant shall be solely responsible for security inside its Premises. Tenant shall provide Landlord with the name of any security company with whom Tenant contracts for security inside its Premises ("**Tenant's Security Provider**") and, if request, the names of any employees of Tenant's Security Provider who will be responsible for providing security services to the Premises ("**Tenant Security Provider Parties**"). Tenant shall give Landlord prior written notice of any change in such Tenant's Security Provider and/or Tenant's Security Provider Parties. Tenant shall comply, and cause to be complied, with any and all such safety and security protocols, procedures and requirements

adopted by Landlord, the Security Contractor, the San Francisco Municipal Transit Agency, San Francisco Police Department (SFPD), San Francisco Sheriff's Department (SFSD), and any transit agency or rail operator conducting operations at the Center. Without limiting the foregoing, Tenant shall alert appropriate law enforcement authorities, including Landlord, the Security Contractor, the SFMTA Police Department, SFSD and SFPD, of any and all suspicious activities, or individuals in, or around the Premises.

#### Article 6 – Utility Services

(a) Services. Landlord shall provide in the Center the following utility services: (i) city water from the regular Center outlets for drinking, lavatory and toilet purposes; (ii) reasonable electrical wiring and facilities and power for normal Center use as determined by Landlord; (iii) reasonable sewage outlets; and (iv) heating, ventilation, and air conditioning, to a point determined by Landlord, when necessary for normal comfort for normal use in the Premises, during the hours of operation set forth in Section 21(a) below. Tenant shall provide janitorial service to the Premises. All extensions of the facilities requested by Tenant for said utility services from said points shall be at the sole cost and expense of Tenant. In the event of any change desired by Tenant, as to said points of supply by Landlord, the expense of making such changes or alterations shall be at the sole cost of Tenant.

(b) Tenant's Payment of Utility Charges. Tenant agrees to pay directly to the applicable utility service provider all charges for utility services supplied to the Premises for which there is a separate meter and/or submeter. If there is no meter or submeter, Tenant shall pay Landlord, as Additional Rent, Tenant's share of utility services supplied to the Premises upon billing by Landlord (including all fees, charges and costs incurred by Landlord in administering or managing such utility services). If Tenant fails to pay when due any charges referred to in this Section 6(b), Landlord may pay the charge and Tenant shall reimburse Landlord upon demand, together with interest at the Interest Rate from the demand date. Landlord shall have the option from time to time to supply any and all utilities to the Premises in accordance with the terms of a program applicable to the majority of tenants in the Center. Tenant shall comply with all of the requirements of such program.

(c) Interruptions. Subject to the provisions of Section 9(a) concerning Landlord's repair obligations concerning such utility lines, Landlord shall not be liable to Tenant in damages or otherwise, if utilities are interrupted or terminated because of Landlord's repairs, installations or improvements to the Common Areas, or any other cause whatsoever except for Landlord's intentional interruption or termination of utilities other than in connection with any such repairs, installations or improvements, nor shall any such interruption or termination relieve Tenant of the performance of any of its obligations hereunder or be construed as a constructive or actual eviction of Tenant from the Premises.

(d) Government Programs. If any governmental entity promulgates or revises any statute, ordinance or building, fire or other code, or imposes mandatory controls or guidelines on Landlord or the Center or any part thereof, relating to the use or conservation of energy, water, gas, light, telecommunications services or electricity or the provision of any other utility or service provided with respect to this Lease, or if Landlord is required to make alterations to the Center in order to comply with such mandatory controls or guidelines, Landlord may comply with such mandatory controls or guidelines, or make such alterations to the Center. In addition to and without limiting the foregoing, if any governmental entity promulgates any voluntary controls or guidelines relating to the use or conservation of energy, water, gas, light, telecommunications services or electricity or the provision of any other utility or service provided with respect to this Lease, Landlord may, in its sole discretion, comply with such voluntary controls or guidelines (including, but not limited to, making any alterations to the Center in order to comply with such voluntary controls or guidelines); provided, however, that Tenant shall not be required to incur any material cost or expense in connection with Landlord's compliance with any such voluntary controls or guidelines. Neither compliance nor the making of any alterations in accordance with and as contemplated under this Section 6(d) shall entitle Tenant to any damages, relieve Tenant of

the obligation to pay any of the sums due or to perform each of its covenants hereunder, or constitute or be construed as a constructive or other eviction of Tenant.

(e) Trash. Tenant shall, on a periodic basis and no less frequently than required by Landlord from time to time, remove all trash and garbage from the Premises and deposit same in the trash compactor for the Center (the “**Compactor**”) located in the trash enclosure area (the “**Trash Enclosure**”) designated by Landlord and/or its property manager per Center Rules and Regulations. Tenant shall also (i) separate all recyclable materials for collection as required by local ordinances or the trash collection contractor servicing the Center and (ii) deposit such recyclable materials in the Trash Enclosure. Landlord shall contract for the regular removal of trash from the Compactor and of recyclable materials from the Trash Enclosure. Tenant shall ensure that (A) all of non-recyclable portion of its trash is deposited in the Compactor and not strewn on the ground adjacent thereto, (B) the recyclable portion of its trash is deposited in any applicable recycling bins located in the Enclosure Area or otherwise in the manner reasonably designated by Landlord from time to time and (C) the Compactor is operated by Tenant in the manner designated by Landlord from time to time. Landlord shall have the right to designate a third party contractor to manage the waste and recycling stream at the Center.

#### Article 7 – Additional Construction

Without limiting Section 1.2(b)(ii) above, Landlord shall have the right, at all times and from time to time throughout the Term, to: (a) alter the boundaries, change the area, size, level, location and/or arrangement of the Center or any part thereof other than the Premises, including, without limitation, the Common Areas and any points of access thereto; (b) construct other structures or improvements in the Common Areas (including, without limitation, kiosks), other portions of the Center, and make alterations and additions thereto, or re-arrangements thereof, demolish parts thereof and/or construct additional buildings or facilities adjoining or proximate to the Center (including, without limitation, building additional stories above or below the Center (including but not limited to the “Train Box”)); (c) make changes and additions to the pipes, conduits and ducts or other structural and nonstructural installations in the Premises where desirable to serve the Common Areas, other premises in the Center or to facilitate expansion or alteration of the Center (including, without limitation, the construction and erection of columns and support facilities), but shall not unreasonably interfere with the operation of Tenant’s business at the Premises consistent with the Permitted Use, and shall repair any damage to the Premises arising in the course of such changes and additions; (d) add additional real property to the Center or remove real property therefrom; (e) temporarily obstruct or close off the Common Areas or any parts thereof for purpose of maintenance, repair, construction or expansion of the Center and/or Structure; (f) grant easements in, on or across the Center. to expand or contract the Center; (g) change the name of the Center; and (f) affix, maintain or remove any signs on the exterior and on the interior of the Center. Tenant hereby agrees that no actions taken by Landlord under and in accordance with Article 7 shall in any way constitute a constructive eviction of Tenant nor entitle Tenant to any credit against Rent (as hereinafter defined) or other compensation therefor. Notwithstanding the foregoing, in the exercise of Landlord’s rights under this Article 7, except in the event of an emergency or in the case of any action taken to avoid a condemnation of any portion of the Center, Landlord shall not unreasonably impair the visibility of Tenant’s Premises in any material respect or unreasonably interfere with Tenant’s access, ingress and egress to and from the Premises in any material respect.

#### Article 8 – Subordination and Attornment

This Lease shall be subject to and subordinated at all times to: (i) all ground or underlying leases which are now or may hereafter be executed affecting the Center (each a “**Prime Lease**”), and (ii) the lien of all mortgages, deeds of trust and public financing indentures in any amount or amounts whatsoever now or hereafter placed on or against all or a portion of the Center or Landlord’s interest or estate therein (each a “**Lender’s Lien**”), all without the necessity of having further instruments executed on the part of Tenant to effectuate such subordination. Notwithstanding the foregoing, in the event of a (A) foreclosure

of any Lender's Lien or of any other action or proceeding for the enforcement thereof, or of any sale thereunder, and if such Lender's Lien so provides, or (B) termination of any Prime Lease, however such termination is caused, this Lease shall not be barred, terminated, cut off or foreclosed, nor shall the rights and possession of Tenant hereunder be disturbed if Tenant is not then in default in the payment of rental or other sums or otherwise in default under the terms of this Lease, and Tenant shall attorn to, as applicable, the purchaser at such foreclosure sale or other action or proceeding, or lessor under a Prime Lease, or, if requested by any such purchaser or lessor under a Prime Lease, enter into a new lease with such purchaser or lessor, as applicable, for the balance of the Term then remaining, upon the same terms and provisions as are contained in this Lease. Tenant shall execute and deliver within ten (10) days after demand such further documents or instruments evidencing the subordination of this Lease to any such Prime Lease and Lender's Lien as may reasonably be required by Landlord or by any lender or lessor. Notwithstanding anything to the contrary set forth above, any beneficiary under any deed of trust or mortgagee under any mortgage may at any time subordinate its deed of trust or mortgage to this Lease in whole or in part, without any need to obtain Tenant's consent, by execution of a written document subordinating such deed of trust or mortgage to this Lease to the extent set forth in such document and thereupon this Lease shall be deemed prior to such deed of trust or mortgage to the extent set forth in such document without regard to their respective dates of execution, delivery and/or recording. In that event, to the extent set forth in such document, the beneficiary under such deed of trust or the mortgagee under such mortgage shall have the same rights with respect to this Lease as would have existed if this Lease had been executed and a memorandum thereof recorded prior to the execution, delivery and recording of such deed of trust or mortgage.

#### Article 9 – Repairs and Maintenance

(a) Landlord's Obligations. Except as set forth in this Article 9, Landlord shall repair and maintain, in good condition and repair, at Landlord's cost, (i) the structural components of the Center, including the foundations, roofs and exterior surfaces of the exterior walls of the Center but specifically excluding doors, door frames, door checks, windows, window frames and storefronts and storefront awnings, (ii) the Common Areas, and (iii) the heating, ventilating, air conditioning, plumbing, electrical, fire protection, life safety, security and other mechanical, electrical and communications systems of the Center the Building Systems serving the Center (collectively, the "**Building Systems**") up to the point of connection with the Premises; provided, however, Tenant shall be reimburse Landlord upon demand for any repairs or maintenance required as a result of (A) Tenant's negligence or willful acts, or those of anyone claiming by, through or under Tenant, (B) Tenant's failure to observe or perform any condition or agreement contained in this Lease, or (C) any Alterations made by Tenant or anyone claiming by, through or under Tenant. Notwithstanding anything to the contrary contained herein, Landlord shall not be liable to Tenant for failing to make any repairs or to perform any maintenance required to be made by Landlord under this Lease until Landlord has had a reasonable opportunity to repair the same after being notified of the need for such repair (but in no event less than thirty (30) days following such notice).

(b) Tenant's Obligations. Tenant shall, at all times to Landlord's reasonable satisfaction and at Tenant's expense, keep all parts of the Premises, including, as applicable, any heating, ventilation and cooling equipment exclusively serving the Premises ("**HVAC**"), utility lines from and after the point of connection with the Premises, and all equipment, fixtures, floor coverings, doors, door frames, door checks, windows, window frames, plate glass and storefronts and storefront awnings in good order and repair and in a clean, sanitary and safe condition and in accordance with all applicable laws, ordinances, orders, rules, regulations and requirements of (i) federal, state, county, municipal and other governmental or quasi-governmental agencies having or claiming jurisdiction over the Premises or the Center, (ii) the insurance underwriting board or insurance inspection bureau having or claiming jurisdiction, and (iii) all insurance companies insuring all or any part of the Premises or improvements or both ((i), (ii) and (iii), collectively, "**Requirements**"). Tenant shall, at Tenant's expense, maintain a contract for the regular repair and maintenance of the HVAC with a contractor approved by Landlord in writing, such approval not to be unreasonably withheld; provided, however, Landlord shall have the right, at Landlord's option,

to retain a third party contractor to provide the regular maintenance and repair of the HVAC in which event Tenant shall reimburse Landlord, within ten (10) days of receipt of a written invoice, for all costs and expenses charged by such third party contractor for the maintenance and repair of the HVAC. If Tenant refuses or neglects to make repairs and/or maintain the Premises, or any part thereof, in a first class condition (including, without limitation, any failure by Tenant to keep the Premises free of vermin or any other pests), Landlord shall have the right, but not the obligation, to make such repairs or perform such maintenance on behalf of or for the account of Tenant (A) immediately, in the event of an emergency or (B) upon ten (10) days' written notice of its election to do so, in non-emergency circumstances, if Tenant does not commence to make such repairs and/or perform such maintenance during such ten (10) day period, or if Tenant after commencing same fails to diligently prosecute the same to completion. In any such event, the direct cost of such work together with any incremental property management costs incurred by Landlord shall be paid for by Tenant as Additional Rental upon receipt of an invoice therefor.

(c) Waiver. Landlord shall not be liable for, and there shall be no abatement of rent on account of, any interference with Tenant's business arising from any repairs, maintenance, alteration or improvement in or to any portion of the Premises, Common Areas, and/or Center or in to the fixtures, appurtenances or equipment therein. Tenant hereby expressly waives the right to make repairs at Landlord's expense or in lieu thereof to vacate the Premises as provided for in Section 1941 and Section 1942 of the California Civil Code, any amendment thereof or any law of similar import that may hereafter be enacted.

#### Article 10 – Alterations

(a) Work Letter. The Premises are being delivered to Tenant in accordance with the Work Letter attached as Exhibit B. All Tenant Improvements (as described in the Work Letter) shall be performed in accordance with the Work Letter and Section 10(c) below.

(b) Alterations.

(i) Following the completion of the Tenant Improvements (as described in the Work Letter attached hereto as Exhibit B), Tenant shall not make any alterations, modifications or improvements to the Premises (collectively, "**Alterations**") without the prior written consent of Landlord, which consent (A) may be withheld in Landlord's sole discretion for Alterations affecting any Building Systems or structural components of the Center (collectively, "**Structural Alterations**"), but (B) shall not be unreasonably withheld for any other Alterations. Landlord has established a design review process (the "**Design Review Process**") for the Center and specifications (the "**Tenant Design Guidelines**") for the Center to be used in the construction of any Alterations in the Premises, which Design Review Process and Tenant Design Guidelines, each as the same may be amended and modified from time to time, are available upon request. In connection with any request for consent to any Alterations under this Section 10(b), Tenant shall adhere to the Design Review Process and the Tenant Design Guidelines.

(ii) Subject to Landlord's right to require their removal as hereinafter provided in this Section 10(b), all Alterations and any improvements to the Premises comprising of Tenant Improvements (as described in the Work Letter attached hereto as Exhibit B) (collectively, "**Improvements**") shall become the property of Landlord and shall be surrendered with the Premises upon the expiration or sooner termination of the Term. Unless otherwise agreed in writing, Landlord may require that any or all Improvements be removed by Tenant, at Tenant's expense, by the expiration or sooner termination of the Term, notwithstanding Landlord's consent to their installation. Landlord may require Tenant to remove, at Tenant's expense and at any time, all or any part of the Improvements made without Landlord's consent required hereunder.

(iii) Prior to commencement of construction of the Alterations, Tenant shall deliver to Landlord any required building permit and other governmental authorization covering the Alterations. All Alterations shall be made by Tenant at Tenant's sole cost and expense and Tenant shall pay promptly for any work done by Tenant (or material furnished therefor) in, on or about the Premises. Tenant shall give Landlord at least ten (10) days' notice prior to commencing any Alterations to allow Landlord time to post a Notice of Non-Responsibility. During construction of the Alterations, Tenant shall require its contractor to maintain insurance in accordance with the Insurance Requirements set forth in Exhibit C attached hereto. Any and all of the Improvements shall (A) be completed in accordance with plans approved by Landlord within a reasonable period of time, subject to a firm outside date which shall be reasonably determined by Landlord, on a case-by-case basis based on the extent and nature of the applicable Alteration, at the time Landlord consents to the same, (B) be carried out in a good, workmanlike and prompt manner, (C) comply with all applicable Requirements, and (D) be subject to monitoring and inspection by Landlord or its employees, agents or contractors. With respect to any Structural Alterations Tenant shall reimburse Landlord upon demand for all costs incurred by Landlord in connection with the review and approval of the proposed Structural Alterations and for all costs incurred in monitoring construction of such Structural Alterations. Tenant shall not use any portion of the Common Areas in connection with the making of any Alterations, nor shall Tenant store any materials in such areas. Upon completion of any Alterations, Tenant shall (1) cause a Notice of Completion to be recorded in the office of the Recorder of the City and County of San Francisco in accordance with Section 3093 of the Civil Code of the State of California or any successor statute, (2) deliver to Landlord a reproducible copy of the "as built" drawings of the Alterations and CAD files, and (3) deliver to Landlord evidence of payment, contractors' affidavits and full and final waivers of all liens for labor, services or materials.

(iv) Related Costs. If any Alterations which Tenant desires to construct would result in Landlord being required to make any alterations and/or improvements to other portions of the Center in order to comply with any applicable Requirements (including, without limitation, ordinances intended to provide full access to handicapped persons), then Tenant shall be precluded from making such Alterations unless Tenant agrees in writing to pay for all of Landlord's costs (the "**Related Costs**") for such related alterations and/or improvements, including, without limitation, architectural, permitting, construction and construction management costs. Landlord's consent to any such Alterations shall be conditioned upon receipt of Tenant's advance payment in the amount of one hundred percent (100%) of the total estimated Related Costs. In the event of any subsequent increase in such estimate including, without limitation, as a result of any change orders requested by Landlord, Tenant shall pay to Landlord upon demand one hundred percent (100%) of the amount of such increase. The balance, if any, of the actual Related Costs over such prior advance payment(s) received by Landlord from Tenant, shall be payable by Tenant as additional rental within ten (10) days following receipt of Landlord's invoice therefor.

(c) Labor Harmony. Tenant shall not, at any time prior to or during the Term, use any contractors, laborers or materials the use of which would create any conflicts with other contractors and/or laborers employed by Landlord in the construction, maintenance or operation of the Center or would cause any jurisdictional or other labor disputes thereat. Without limiting the foregoing or any other provision of this Lease, Tenant shall comply with the requirements set forth in Section 24 of Exhibit F attached hereto.

#### Article 11 – Fixtures and Personal Property

Any trade fixtures, signs and other personal property of Tenant not permanently affixed to the Premises shall remain the property of Tenant, and Tenant shall have the right, at any time, and from time to time, to remove any and all of its trade fixtures, signs and other personal property which it may have stored or installed in the Premises, including but not limited to counters, shelving, showcases, mirrors and other movable personal property. Tenant at its expense shall immediately repair any damage caused to the Premises by reason of the removal of any such trade fixtures, signs, and other personal property.

## Article 12 – Compliance with Laws

(a) Compliance Generally. Tenant shall comply with all present and future Requirements affecting the use and occupancy of the Premises and the cleanliness, safety and operation thereof, and with any and all recorded covenants, conditions and restrictions affecting the Center or any portion thereof, whether in effect at the time of the execution of this Lease, or adopted or recorded any time thereafter, and whether or not within the present contemplation of the parties. Without limiting the foregoing, Tenant shall comply with the regulations and requirements of any insurance underwriter, inspection bureau or similar agency with respect to the Premises and shall permit Landlord to comply with such recommendations and requirements to the extent compliance is Landlord's obligation hereunder or pursuant to the subject recommendation or requirement. If Tenant's conduct or use of the Premises causes any increase in the premium for such insurance policies, then Tenant shall reimburse Landlord for any such increase.

(b) Certified Access Specialist Inspections. A Certified Access Specialist ("CASp") can inspect the subject Premises and determine whether the subject Premises comply with all of the applicable construction-related accessibility standards under state law. Although state law does not require a CASp inspection of the subject Premises, the commercial property owner or lessor may not prohibit the lessee or tenant from obtaining a CASp inspection of the subject premises for the occupancy or potential occupancy of the lessee or tenant, if requested by the lessee or tenant. The parties shall mutually agree on the arrangements for the time and manner of the CASp inspection, the payment of the fee for the CASp inspection, and the cost of making any repairs necessary to correct violations of construction-related accessibility standards within the Premises.

(c) Hazardous Materials. Tenant shall at all times and in all respects comply with all Environmental Laws (as hereinafter defined). Tenant shall not cause or permit the escape, disposal or release of any Hazardous Materials (as hereinafter defined) to or from the Premises. Tenant shall not cause or permit the generation, manufacture, production, processing, storage or use of any Hazardous Materials on the Premises, nor allow to be brought into the Center any such Hazardous Materials; provided, however, Tenant may use and store reasonable quantities of cleaning and office products customarily used in Tenant's retail business so long as such use and storage, and any disposal thereof, is done in compliance with all applicable Environmental Laws and with prudent industry practices regarding management of such substances. If any lender or governmental agency requires testing to ascertain whether there has been any release of Hazardous Materials, then the reasonable costs thereof shall be reimbursed by Tenant to Landlord upon demand as additional charges if such requirement applies to the Premises. In addition Tenant shall execute affidavits, representations and the like from time to time at Landlord's request concerning Tenant's best knowledge and belief regarding the presence of Hazardous Materials on the Premises. In all events, Tenant shall indemnify, defend and hold Landlord and the other Landlord Entities (as defined in Article 14 below) harmless, in the manner provided in Section 14(a) hereof, from any and all losses, damages, claims, costs and expenses (including but not limited to attorneys' fees), judgments, suits, and direct or vicarious liability for any damage to any property or injury, illness or death of any person incurred in connection with or arising from (i) any release of Hazardous Materials on the Premises occurring while Tenant is in possession, (ii) any release of Hazardous Materials elsewhere in the Center if caused by Tenant or persons acting under Tenant, or (iii) any failure to perform Tenant's obligations regarding Hazardous Materials provided for under this Lease. The covenants contained herein shall survive the expiration or earlier termination of the Lease. As used herein, "**Hazardous Materials**" means (A) petroleum or chemical products or wastes, whether in liquid, solid, or gaseous form, or any fraction or by-product thereof, (B) asbestos or asbestos-containing materials, (C) polychlorinated biphenyls (pcbs), (D) radon gas, (E) any explosive or radioactive substances, (F) lead or lead-based paint, or (G) any other substance, material, waste or mixture which is or shall be listed, defined, or otherwise determined by any governmental authority to be hazardous, toxic, dangerous or otherwise regulated, controlled or giving rise to liability under any Environmental Laws. As used herein, "**Environmental Laws**" means any federal, state or local law (whether imposed by statute,

ordinance, rule, regulation, administrative or judicial order, or common law), now or hereafter enacted, governing health, safety, industrial hygiene, the environment or natural resources, or Hazardous Materials, including, without limitation, such laws governing or regulating (x) the use, generation, storage, removal, recovery, treatment, handling, transport, disposal, control, release, discharge of, or exposure to, Hazardous Materials, (y) the transfer of property upon a negative declaration or other approval of a governmental authority of the environmental condition of such property, or (z) requiring notification or disclosure of releases of Hazardous Materials or other environmental conditions whether or not in connection with a transfer of title to or interest in property.

#### Article 13 – Insurance

(a) Tenant’s Insurance. Tenant shall procure and maintain the insurance, in the amounts and forms, as described in the Insurance Requirements attached hereto as Exhibit C. Landlord may, upon reasonable notice and reasonable grounds increase or change the required insurance hereunder, in which event Tenant shall obtain such required insurance. The minimum amounts of insurance required hereunder shall not be construed to limit the extent of Tenant’s liability under the Lease. Approval of the insurance by Landlord shall not relieve or decrease Tenant’s liability hereunder.

(b) Waiver of Subrogation. Notwithstanding anything to the contrary herein, Tenant waives any right of recovery against Landlord for any loss or damage to the extent the same is required to be covered by Tenant’s insurance hereunder. Tenant shall obtain from its insurer a waiver of subrogation the insurer may have against Landlord or any other Landlord Entity in connection with any loss or damage covered by Tenant’s property insurance and worker’s compensation insurance policies.

#### Article 14 – Indemnification and Waiver

(a) Indemnification. Except to the extent caused solely and exclusively by the willful misconduct of Landlord, Tenant shall indemnify, protect, defend and hold Landlord and the other Landlord Entities harmless from and against any and all losses, damages, claims, costs and expenses (including but not limited to attorneys’ fees), judgments, suits, and direct or vicarious liability for any damage to any property or injury, illness or death of any person incurred in connection with or arising from: (i) any cause whatsoever occurring at any time in or on the Premises; or (ii) any acts, omissions or negligence of Tenant or of any person claiming by, through or under Tenant, or of the contractors, agents, servants, employees, licensees, guests or invitees of Tenant or any such person occurring in, on, or about any part of the Center other than the Premises. As used herein, “**Landlord Entities**” shall mean Landlord, each of the entities specifically identified as “Additional Insureds” in Exhibit C attached hereto (as the same may be amended from time to time), the member agencies of the TJPA and any and all subsidiaries and affiliates of any of the foregoing, their agents, servants, directors, officers, employees and the holders of all or any part of any direct or indirect equity or ownership interest(s) (whether stock, partnership interest, beneficial interest in a trust, membership interest, or other interest of an ownership or equity nature) in any entity at any tier of ownership that directly or indirectly owns or holds any ownership or equity interest in any of the foregoing. The provisions of this Section 14(a) shall survive the expiration or earlier termination of this Lease with respect to any damage, injury, illness or death caused by an event, action or failure to act occurring prior to such expiration or termination.

(b) Waiver. Neither Landlord nor any other Landlord Entity shall be liable or responsible in any way for, and Tenant waives all claims against Landlord and the other Landlord Entities and assumes all risk with respect to or arising out of (i) any damages for which Tenant is required to insure hereunder, (ii) any death or any injury of any nature whatsoever that may be suffered or sustained by Tenant or any employee, licensee, invitee, guest, agent or customer of Tenant or any other person claiming through or under Tenant, from any causes whatsoever except if caused solely by the willful misconduct of Landlord, and/or (iii) any loss, damage or injury to any property belonging to Tenant or its employees, agents, customers, licensees, invitees, guests or any other person except if caused solely by the willful



misconduct of Landlord. Without limiting the generality of the foregoing, neither Landlord nor any other Landlord Party shall be liable for any damage or damages of any nature whatsoever including, without limitation, consequential damages or loss of profit or business opportunity caused by explosion, fire, theft or breakage, by any sprinkler, drainage or plumbing systems, by the failure for any reason to supply adequate drainage, by the interruption of any public utility or service, by steam, gas, water, rain or other substances leaking, issuing or flowing into any part of the Premises, by natural occurrence, acts of the public enemy, riot, strike, insurrection, war, court order, requisition or order of governmental body or authority, or for any damage or inconvenience which may arise as a result of repair, maintenance or alteration of any part of the Center, or by anything done or omitted to be done by any tenant, occupant or person in the Center. The provisions of this Section 14(b) shall survive the expiration or earlier termination of this Lease.

#### Article 15 – Damage and Destruction

In the event of a fire or other casualty in the Premises, Tenant shall immediately give notice thereof to Landlord. The following provisions shall apply to fire or other casualty occurring in the Premises and/or the Center:

(a) If the damage is limited solely to the Premises (including without limitation any Improvements made by or for the benefit of Tenant), unless this Lease is otherwise terminated pursuant to the provisions of Section 15(b) or (c) below, then Tenant shall be obligated to repair and rebuild the non-structural portions of the Premises at Tenant's sole cost and expense and shall proceed diligently to do so. For purposes of this Article 15, "non-structural portions of the Premises" includes, without limitation, infill block walls, stud walls, the Premises storefront and all Improvements, but excludes portions of the Premises consisting of primary structural elements of the Center ("**Structural Premises Portions**") including, without limitation, elevator shafts, support columns and shear walls.

(b) If any portions of the Center outside the boundaries of the Premises (the "**Non Premises Portions**") are damaged or destroyed (whether or not the Premises are also damaged or destroyed) or any Structural Premises Portions are damaged or destroyed, and the Non Premises Portions and/or Structural Premises Portions, as applicable, can be repaired within one hundred eighty (180) days (the "**Restoration Period**") following the date of the damage or destruction (the "**Casualty Date**"), and provided Landlord determines it is economically feasible to do so, then Landlord shall so inform Tenant within sixty (60) days following the Casualty Date and Landlord shall diligently proceed to repair such Non Premises Portions and/or such Structural Premises Portions, as applicable; provided, however, that Landlord shall have no obligation to repair or restore any Tenant Improvements or Alterations performed by or for the benefit of Tenant. If such damage cannot, in Landlord's opinion, be repaired within the Restoration Period, then Landlord may nonetheless elect, upon notice to Tenant within sixty (60) days after the Casualty Date, to repair such damage to the Non Premises Portions and/or the Structural Premises Portions, as applicable, and shall thereafter diligently pursue the completion thereof. If Landlord so elects to repair such damage and even if, notwithstanding the provisions of Section 15(c) below, such repairs would require the demolition and reconstruction of the Premises in connection therewith (which reconstruction would be the obligation of Tenant, at Tenant's sole cost and expense, to the extent of the portions of the Premises other than the Structural Premises Portions), then this Lease shall remain in full force and effect, but otherwise Landlord shall notify Tenant within sixty (60) days following the Casualty Date of the termination of this Lease effective as of the date of such notice.

(c) A total destruction of the Premises shall automatically terminate this Lease. The provisions of this Lease, including this Article 15, constitute an express agreement between Landlord and Tenant with respect to any and all damage to, or destruction of, all or any part of the Premises or any other portion of the Center. In the event of a conflict between California Civil Code Sections 1932(1) and (2), 1933(4) and 1942 and this Lease with respect to any destruction of the Premises, the terms and

provisions of this Lease shall control. Nothing herein shall obligate Landlord to perform any repairs or reconstruction except as set forth in Section 15(b).

(d) If the Premises are partially destroyed or damaged, Tenant shall have no claim against Landlord for any damage suffered by reason of any such damage, destruction, repair or restoration nor shall Landlord be liable for any inconvenience or annoyance to Tenant or its visitors, or injury to Tenant's business resulting in any way from such damage or the repair thereof. Notwithstanding the foregoing, during any period when Tenant's use of the Premises is significantly affected by any damage or destruction resulting from a fire or other casualty and the Premises (or portion thereof) are not occupied by Tenant as a result thereof, the Base Rent shall abate in the proportion by which (i) the area of the part of the Premises the use of which is so affected bears to (ii) the Floor Area of the Premises, beginning on the first (1st) day following any deductible period applicable to Landlord's business income insurance or, if no such insurance is maintained by Landlord, then beginning on the sixth (6<sup>th</sup>) day following the event causing the subject damage or destruction, as reasonably determined by Landlord, until such time as the Premises are made tenantable or Tenant otherwise occupies the Premises for the purposes permitted under this Lease; provided, however, that there shall be no such abatement if the damage or destruction resulted in whole or in part from the negligence or willful acts of Tenant, its agents or employees.

(e) The proceeds from any insurance paid by reason of damage to or destruction of the Center or any part thereof, which is insured by Landlord or its property manager, shall belong to and be paid to Landlord.

(f) If this Lease is not terminated as provided above, then Tenant shall repair and replace its merchandise, trade fixtures, furnishings and equipment in a manner and to a condition at least equal to that which existed prior to its damage or destruction. Except as herein expressly provided to the contrary, this Lease shall not terminate nor shall there be any abatement of rent or other charges or items of additional rent as the result of a fire or other casualty.

#### Article 16 – Eminent Domain

(a) **Taking.** If all or a portion of the Premises are taken under the power of eminent domain by any public or quasi-public authority, or if all or any part of the Premises is sold or transferred in lieu thereof, this Lease shall terminate and expire as to the part so taken as of the date of such taking, and, in the case of a partial taking, either Landlord or Tenant may terminate this Lease as to the balance of the Premises by giving notice to the other, in writing, within thirty (30) days after the date of such taking; provided, however, that a condition to the exercise of such right to terminate by Tenant shall be that the portion of the Premises shall be of such extent and nature as substantially to handicap, impede and impair Tenant's use of the balance of the Premises for the purposes permitted by this Lease. If a material part of the Center is condemned or taken or if substantial alteration or reconstruction of the Center is, in Landlord's opinion, necessary or desirable as a result of a condemnation or taking, whether or not any portion of the Premises is condemned or taken, Landlord may terminate this Lease by written notice to Tenant within thirty (30) days after the date of such taking. In the event of a taking of the Premises which results in a termination of this Lease, effective as of the date of the taking ("**Taking Date**"), Base Rent and all other charges previously paid by Tenant to Landlord hereunder shall be prorated as of the Taking Date and thereafter Landlord and Tenant shall have no further obligations under this Lease except for those which survive the termination of this Lease pursuant to its terms. In the event of a partial taking of the Premises which does not result in a termination of this Lease, Base Rent shall be equitably reduced by Landlord. Tenant hereby waives the provisions of any applicable statute allowing either party to petition the court of competent jurisdiction to terminate this Lease in the event of a partial taking of the Premises, including, without limitation, any and all rights it might otherwise have pursuant to Section 1265.130 of the California Code of Civil Procedure.

(b) Awards. Landlord shall be entitled to any and all compensation, damages, income, rent, awards, or any interest therein whatsoever which may be paid or made in connection with a taking, and Tenant shall have no claim against Landlord for the value of any unexpired term of this Lease or otherwise. Tenant shall be entitled to initiate a separate action for its relocation costs (except with respect to any taking or partial taking by any governmental or quasi-governmental authority to which the waiver set forth in Section 26(f) applies), and for loss of any Alterations made by Tenant and trade fixtures installed at Tenant's cost, provided any award to Tenant in such action does not reduce the award which would otherwise accrue to Landlord.

#### Article 17 – Assignment and Subletting

(a) Transfers. Tenant shall not directly or indirectly transfer, assign, sublet, enter into license or concession agreements, change ownership, mortgage, pledge, encumber or hypothecate this Lease or the Tenant's interest in and to the Premises (individually and collectively, a “**Transfer**”) without first procuring the written consent of Landlord, which consent shall not be unreasonably withheld. Any attempted Transfer without the written consent of Landlord shall constitute an immediate Event of Default hereunder and shall be voidable at Landlord's election. The prohibitions of this Article 17 shall apply to a Transfer when such transfer occurs by operation of law, legal process, receivership, bankruptcy or otherwise.

(b) Changes in Tenant. If Tenant is a corporation, any dissolution, merger, consolidation or other reorganization of Tenant (excluding a reorganization where Tenant remains the controlling party), or the sale or other transfer of a controlling percentage of the capital stock of Tenant (other than in a public offering) or the sale of fifty percent (50%) or more of the value of the assets of Tenant, shall be deemed a voluntary assignment of this Lease by Tenant. The phrase “controlling percentage” shall mean the ownership of, and the right to vote, stock possessing fifty percent (50%) or more of the total combined voting power of all classes of Tenant's capital stock issued, outstanding, and entitled to vote for the election of directors. The preceding two sentences shall not apply to corporations the stock of which is traded through an exchange or over the counter. If Tenant is a partnership, a withdrawal or change, whether voluntary, involuntary, or by operation of law, of any partner or partners owning a total of fifty percent (50%) or more of the partnership, or the dissolution of the partnership, shall be deemed a voluntary assignment of this Lease by Tenant. If Tenant is a limited liability company, a withdrawal or change, whether voluntary, involuntary or by operation of law, of either (i) any managing member or (ii) any member or members owning fifty percent (50%) or more of the total membership interests in the company, or the dissolution of the company, shall be deemed a voluntary assignment of this Lease by Tenant. If Tenant consists of more than one person, a purported assignment, voluntary, involuntary, or by operation of law, by any one of the persons executing this Lease shall be deemed a voluntary assignment of this Lease by Tenant.

(c) Subsequent Transfers. The consent by Landlord to any Transfer shall not constitute a waiver of the necessity for such consent to any subsequent Transfer. In no event shall any assignee or subtenant of Tenant or any subsequent assignee or subtenant be permitted to further transfer, assign, sublet, enter into license or concession agreements, change ownership or hypothecate this Lease or its interest in and to the Premises or this Lease in whole or in part, or otherwise permit occupancy of all or any part thereof by anyone with, through or under it, without first procuring the written consent of Landlord in accordance with this Article 17.

(d) Documentation. Each Transfer to which there has been consent shall be by instrument in writing, in form reasonably satisfactory to Landlord, and shall be executed by Tenant and the transferee, assignee, sublessee, licensee, concessionaire or mortgagee which shall agree in writing for the benefit of the Landlord to assume and be bound by, the terms, covenants and conditions of this Lease to be performed by Tenant and shall expressly waive entitlement to any and all relocation assistance and

benefits in connection with this Lease or the subject sublease, as applicable. One executed copy of such written instrument shall be delivered to Landlord within ten (10) days of the date of execution.

(e) Consent Process. If Tenant intends to effect a Transfer other than a hypothecation of this Lease, Tenant shall give prior written notice of such intent, specifying therein the proposed assignee, sublessee, licensee or concessionaire and providing such information with respect thereto including, without limitation, information concerning the principals thereof and such credit, financial and business experience information relating to the proposed assignee, sublessee, licensee or concessionaire as Landlord requires. Landlord shall within thirty (30) days after receipt of such notice and information elect in writing to either (i) consent to the proposed Transfer, (ii) refuse to consent to the proposed Transfer, or (iii) cancel this Lease. The period of time within which Landlord must respond to a request by Tenant for consent to an assignment of this Lease shall not begin to run until Tenant has provided to Landlord all of the information to which Landlord is reasonably entitled in order to evaluate the proposed transaction. Tenant shall reimburse Landlord upon demand for Landlord's reasonable attorneys' fees and administrative expenses incurred in connection with the review, processing and/or preparation of any documentation of any requested Transfer regardless of whether consent is given or such Transfer is consummated. Tenant waives the provisions of Civil Code Section 1995.310 with respect to remedies available to Tenant should Landlord fail to consent to a Transfer.

(f) Transfer Premium. If Landlord consents to a Transfer, then fifty percent (50%) of any sums or other economic consideration received by Tenant as a result of such Transfer (after deducting the sum of any brokerage commissions paid by Tenant in connection with the Transfer and reasonable attorneys' fees incurred by Tenant in negotiating and documenting the Transfer, which attorneys' fees shall not exceed Two Thousand Five Hundred and No/100 Dollars (\$2,500.00) for each such Transfer, which sum shall be amortized on a straight line over the effective term of the Transfer) whether denominated rent or otherwise, which exceed, in the aggregate, the total sums which Tenant is obligated to pay Landlord under this Lease (prorated as to any sublease, license or concession agreement to reflect obligations allocable to that portion of the Premises subject to such sublease, license or concession agreement) shall be payable to Landlord as Additional Rent under this Lease within ten (10) days of Tenant's receipt from the applicable transferee, without affecting or reducing any other obligation of Tenant hereunder. In addition to the foregoing, Tenant shall deliver to Landlord a statement within thirty (30) days after the end of each calendar year, and within thirty (30) days after the expiration or earlier termination of the Term, specifying with respect to the prior calendar year, (i) each sublease, assignment, licensing and/or concession agreement which was in effect during any portion of the year covered by such statement and (ii) a computation in reasonable detail showing the amounts paid by Tenant to Landlord pursuant to this Section 17(f) (and if the amounts so paid are less than the amounts owed to Landlord under this Section 17(f), the amount of such underpayment) and applicable to (A) the year covered by such statement and (B) prior years. Landlord or its authorized representatives shall have the right at all reasonable times to audit the books, records and papers of Tenant relating to any Transfer, and shall have the right to make copies thereof. If the amounts paid by Tenant to Landlord pursuant to this Section 17(f) respecting any Transfer shall be found understated, Tenant shall, within thirty (30) days after demand, pay the deficiency and, if such amounts are found to be understated by more than two percent (2%), Tenant shall reimburse Landlord for Landlord's costs of such audit.

(g) Effect of Transfer. No Transfer shall release Tenant or any guarantor from its obligations under or in connection with this Lease or alter the primary liability of Tenant to pay Rent due hereunder or be deemed to waive or modify any of the terms and conditions of this Lease. The acceptance of rent by Landlord from any other person shall not be deemed to be a waiver by Landlord of any provision hereof. If any transferee defaults in the performance of any of the terms hereof, Landlord may proceed directly against Tenant without the necessity of exhausting its remedies against such transferee. Landlord may consent to subsequent transfers of this Lease or amendments or modifications to this Lease with transferees of Tenant, without obtaining Tenant's consent thereto, and such action shall not relieve Tenant of its liability under this Lease.

### Article 18 – Access to Premises

Upon telephonic notice to Tenant’s on-site manager or other designated representative (except in an emergency, when no notice shall be required), Landlord, its agents, employees and any person authorized by Landlord, may enter the Premises at reasonable hours for the purpose of: (a) inspecting the condition of same; (b) making such repairs, additions or improvements thereto, or to the Center, as Landlord may elect or be required to make (including, without limitation, any repairs or improvements necessary for compliance with applicable Requirements); (c) exhibiting the same to contractors, prospective purchasers, lenders or, during the last twelve (12) months of the Term or at any time during the continuance of an Event of Default, prospective tenants; (d) determining whether Tenant is complying with its obligations hereunder; (e) supplying any service to be provided by Landlord to Tenant or to any other tenant of the Center; and (f) placing notices, including, without limitation, notices of non-responsibility. Neither Tenant nor any person within Tenant’s control shall interfere with such notices. Except as otherwise provided in this Lease and in cases of emergency, in exercising its rights under this Article 18, Landlord shall use commercially reasonable efforts not to unreasonably disturb Tenant’s conduct of business in the Premises. Tenant hereby waives any claim for damages for any injury or inconvenience to or interference with Tenant’s business, any loss of occupancy or quiet enjoyment of the Premises, and any other loss occasioned by such entry and agrees that no actions taken by Landlord in accordance with this Article 18 shall relieve Tenant of the performance of any of its obligations hereunder or be construed as a constructive or actual eviction of Tenant from the Premises. If entry is desired by Landlord in non-emergency circumstances, Landlord shall so notify Tenant telephonically at the telephone numbers set forth in the Basic Lease Information and after attempting to give or giving such telephonic notice, if the Premises are not made fully available for entry Landlord may (but shall not be obligated to) enter the Premises in any way necessary and Tenant shall indemnify, defend and hold Landlord harmless from and against any loss, liability, or claim occasioned by Tenant’s failure to provide access to the Premises to Landlord. Landlord shall have the right to use any and all means which Landlord may deem proper to enter the Premises in an emergency, and no such entry by Landlord shall under any circumstance be construed or deemed to be a forcible or unlawful entry into, or a detainer of, the Premises or an eviction, actual or constructive, of Tenant from the Premises, or any portion thereof.

### Article 19 – Defaults by Tenant

(a) Events of Default. The following shall each be deemed to be an event of default (“**Event of Default**”) by Tenant under this Lease:

(i) Tenant’s failure to pay when due any installment of Base Rent or Percentage Rent or, if applicable, any Storage Fee (as defined in the Addendum to Lease – Option regarding Storage Space attached hereto); provided, the first two (2) times in any consecutive twelve (12) month period that such failure occurs, such failure shall not constitute an Event of Default unless Tenant has failed to pay the overdue sums in full within five (5) days after Tenant has been given written notice that such payment is overdue; or

(ii) Tenant’s failure to pay any other sum when the same becomes due and payable if such failure continues for more than ten (10) days after written notice thereof from Landlord; or

(iii) Tenant’s failure to perform or observe any other obligations of Tenant hereunder (including, but not limited to, Tenant’s failure to comply with the Rules and Regulations, Naming Rights Requirements, Restaurant Requirements, Governmental Provisions (each as hereinafter defined), or Tenant’s failure to comply with any obligations of Tenant with regard to any Storage Space licensed to Tenant following exercise of its rights under the Addendum to Lease – Option regarding Storage Space attached hereto)) if such failure continues for more than ten (10) days after written notice thereof from

Landlord, unless such default cannot be reasonably cured within such ten (10) day period and Tenant has within such period commenced and is pursuing the curing of such default with due diligence; or

(iv) Tenant's abandonment or vacation of a substantial portion of the Premises, or failure to conduct its business in the manner prescribed herein for a continuous period in excess of five (5) business days; or

(v) Tenant's failure to vacate the Premises immediately upon termination of this Lease; or

(vi) Any Transfer except in strict accordance with the Lease; or

(vii) Any breach of the representations and warranties made by Tenant under Article 25; or

(viii) The leasehold interest of Tenant is levied upon under execution or is attached by process of law or Tenant's failure to contest diligently the validity of any lien or claimed lien or to give sufficient security to Landlord to insure payment thereof or failure to satisfy any judgment rendered thereon and having the same released, and such default continues for ten (10) days after written notice to Tenant; or

(ix) Tenant's becoming insolvent, admitting in writing its inability to pay its debts generally as they become due, filing a petition in bankruptcy or a petition to take advantage of any insolvency statute, making an assignment for the benefit of creditors, making a fraudulent transfer, applying for or consenting to the appointment of a receiver of itself or of the whole or any substantial part of its property, or filing or answering a petition seeking reorganization under the federal bankruptcy laws, as now in effect or hereafter amended, or any other applicable law or statute of the United States or any state thereof; or

(x) A court of competent jurisdiction entering an order, judgment or decree adjudicating Tenant a bankrupt, or appointing a receiver of Tenant, or of the whole or any substantial part of its property without the consent of Tenant, or approving a petition filed against Tenant seeking reorganization or arrangement of Tenant under any applicable federal or state bankruptcy laws, as now in effect or hereafter amended, if such order, judgment or decree is not vacated, set aside or stayed within thirty (30) days from the date of entry thereof.

(b) Remedies. Upon the occurrence of any such Event of Default by Tenant, Landlord shall have, in addition to any other remedies available to Landlord at law or in equity, the option to pursue any one or more of the following remedies, each and all of which shall be cumulative and nonexclusive, without any notice or demand whatsoever:

(i) Landlord may terminate this Lease and Tenant's right of possession of the Premises and recover from Tenant: (A) the worth at the time of award of the unpaid rent which had been earned at the time of termination; plus (B) the worth at the time of award of the amount by which the unpaid rent which would have been earned after termination until the time of award exceeds the amount of such rent loss that Tenant proves could have been reasonably avoided; plus (C) the worth at the time of award of the amount by which the unpaid rent for the balance of the Term of this Lease after the time of award exceeds the amount of such rent loss that Tenant proves could be reasonably avoided; plus (D) any other amount necessary to compensate Landlord for all the detriment proximately caused by Tenant's failure to perform its obligations under this Lease or which in the ordinary course of things would be likely to result therefrom, specifically including but not limited to, brokerage commissions and advertising expenses incurred, expenses of remodeling the Premises or any portion thereof for a new tenant, whether for the same or a different use, and any special concessions made to obtain a new tenant.

The term “rent” as used in this Section 19(b) shall be deemed to be and to mean all sums of every nature required to be paid by Tenant pursuant to the terms of this Lease, whether to Landlord or to others. The “worth at the time of award” of the amounts referred to in clauses (A) and (B) above shall be computed by allowing interest at the Interest Rate. The “worth at the time of award” of the amount referred to in clause (C) above shall be computed by discounting such amount at a rate equal to the discount rate of the Federal Reserve Board of San Francisco at the time of award plus one percent (1%).

(ii) Landlord shall have the remedy described in California Civil Code Section 1951.4 (lessor may continue lease in effect after lessee’s breach and abandonment and recover rent as it becomes due, if lessee has the right to sublet or assign, subject only to reasonable limitations). Accordingly, if Landlord does not elect to terminate this Lease on account of any default by Tenant, Landlord may, from time to time, without terminating this Lease, enforce all of its rights and remedies under this Lease, including the right to recover all rent as it becomes due.

(iii) Landlord may, but shall not be obligated to, make any such payment or perform or otherwise cure any such obligation, provision, covenant or condition on Tenant’s part to be observed or performed (and may enter the Premises for such purposes). In the event of Tenant’s failure to perform any of its obligations or covenants under this Lease, and such failure to perform poses a material risk of injury or harm to persons or damage to or loss of property, then Landlord shall have the right to cure or otherwise perform such covenant or obligation at any time after such failure to perform by Tenant, whether or not any such notice or cure period set forth in Section 19(a) above has expired.

(c) Statutory Notices. Notwithstanding anything to the contrary herein, any notice given by Landlord pursuant to this Article 19 may be the notice required or permitted pursuant to Section 1161 et seq. of the California Code of Civil Procedure or successor statutes, and the provisions of this Lease will not require the giving of a notice in addition to the statutory notice to terminate this Lease and Tenant’s right to possession of the Premises. The periods specified in Section 19(a) above within which Tenant is permitted to cure any default following notice from Landlord will run concurrently with any cure period provided by applicable laws.

(d) Interest. All delinquent Rent and/or other sums due Landlord under the terms of this Lease shall bear interest from the date due until paid at the Interest Rate.

(e) LATE CHARGE. TENANT ACKNOWLEDGES THAT LATE PAYMENT BY TENANT TO LANDLORD OF RENT OR ANY OTHER SUMS DUE HEREUNDER WILL CAUSE LANDLORD TO INCUR COSTS NOT CONTEMPLATED BY THIS LEASE, THE EXACT AMOUNT OF SUCH COSTS BEING EXTREMELY DIFFICULT AND IMPRACTICABLE TO FIX. SUCH COSTS INCLUDE, WITHOUT LIMITATION, PROCESSING AND ACCOUNTING CHARGES, AND LATE CHARGES THAT MAY BE IMPOSED ON LANDLORD BY THE TERMS OF ANY ENCUMBRANCE AND NOTE SECURED BY ANY ENCUMBRANCE COVERING THE PREMISES. THEREFORE, IF ANY INSTALLMENT OF RENT OR ANY OTHER SUM DUE FROM TENANT IS NOT RECEIVED BY LANDLORD WHEN DUE, TENANT SHALL PAY TO LANDLORD ON DEMAND, AND IN ADDITION TO THE INTEREST PROVIDED HEREINABOVE, A SUM EQUAL TO TEN PERCENT (10%) OF THE OVERDUE AMOUNT AS A LATE CHARGE. THE PARTIES AGREE THAT THIS LATE CHARGE REPRESENTS A FAIR AND REASONABLE ESTIMATE OF THE COSTS THAT LANDLORD WILL INCUR BY REASON OF SUCH LATE PAYMENT BY TENANT. ACCEPTANCE OF ANY LATE CHARGE SHALL NOT CONSTITUTE A WAIVER OF TENANT’S DEFAULT WITH RESPECT TO THE OVERDUE AMOUNT, OR PREVENT LANDLORD FROM EXERCISING ANY OF THE OTHER RIGHTS AND REMEDIES AVAILABLE TO LANDLORD.

(f) Disclaimers. No act or thing done by Landlord or its agents during the Term shall be deemed a termination of this Lease or an acceptance of the surrender of the Premises, and no agreement to terminate this Lease or accept a surrender of the Premises shall be valid unless in writing signed by Landlord. Landlord's acceptance of any payments hereunder after the occurrence of an Event of Default shall not be construed as an accord and satisfaction, compromise or waiver of such default, unless Landlord so notifies Tenant in writing. Acts of maintenance or preservation or efforts to relet the Premises or the appointment of a receiver upon initiative of Landlord to protect Landlord's interest under this Lease shall not constitute a termination of Tenant's right to possession. No re-entry or taking possession of the Premises by Landlord shall be considered as an election to terminate this Lease, nor shall it cause a forfeiture of rent or other charges remaining to be paid during the balance of the Term hereof unless a written notice of such intent is given to Tenant or unless the termination hereof is decreed by a court of competent jurisdiction. Notwithstanding any reletting without termination by Landlord because of any default by Tenant, Landlord may at any time after such reletting elect to terminate this Lease for any such default.

#### Article 20 – Surrender of Premises

At the end of the Term or upon sooner termination of this Lease, Tenant shall peaceably deliver up to Landlord possession of the Premises, together with all Improvements not required by Landlord to be removed pursuant to Article 10 above, "broom clean" and with no hazardous conditions or exposed utility connections therein, in the same condition as when received or first installed, reasonable wear and tear and damage due to casualty or condemnation excepted. Tenant shall, upon the expiration or sooner termination of this Lease, remove all signs and other trade fixtures installed by Tenant and repair any damage caused by such removal. Any property not so removed shall be deemed abandoned by Tenant and shall become the property of Landlord and may be removed from the Premises by Landlord and disposed of by Landlord without liability to Tenant. Tenant shall pay to Landlord, upon demand, any and all expenses incurred in such removal and all disposal charges against such property.

#### Article 21 – Tenant's Conduct of Business; Operational Requirements; Center Operations

(a) Hours of Operation. Tenant shall (i) open for business to the public in the entire Premises under the trade name specified in the Basic Lease Information on or before the Commencement Date, fully fixturized, staffed, and stocked with merchandise and inventory, (ii) be continuously open for business during the minimum required hours set forth in the Basic Lease Summary (the "**Minimum Required Hours**"), subject to temporary closures due to permitted remodeling (not to exceed one hundred twenty (120) days in any calendar year), casualty and condemnation (collectively, "**Permitted Closures**"), and (iii) have its display windows, signs and advertising displays adequately illuminated continuously during the Minimum Required Hours and one-half (1/2) hour before and one-half (1/2) hour after Minimum Required Hours. If on any occasion Tenant is not open and conducting business during the Minimum Required Hours (subject to Permitted Closures), Tenant shall provide Landlord with written notice of such closure, which notice shall explain the reason for such closure, within one (1) business day following the date on which such closure occurred. On the third (3rd) and each subsequent occasion during any consecutive twelve (12) month period on which (A) for up to four (4) hours during any day Tenant is not open and conducting business during the Minimum Required Hours (subject to Permitted Closures), then Tenant shall pay, in addition to the Annual Rental and all other sums due hereunder, an amount equal to the per diem Base Rent then in effect, calculated on the basis of a thirty (30) day month, and (B) for more than four (4) hours during any day Tenant is not open and conducting business as required hereunder during the Minimum Required Hours (subject to Permitted Closures), then, at Landlord's option, Tenant shall pay, in addition to the Base Rent, Percentage Rent and all other sums due hereunder, an amount equal to three (3) times the per diem Base Rent then in effect, calculated on the basis of a thirty (30) day month. Tenant acknowledges that failure to open and conduct business during



Minimum Required Hours will (1) be detrimental to the image of the Center and (2) result in decreased traffic in the Center, thereby potentially decreasing the sales volume of other tenants of the Center. The exact amount of the damages caused by Tenant's failure to be open during Minimum Required Hours is extremely difficult and impracticable to fix; therefore, the parties agree that the above-described sums represent fair and reasonable estimates of such damages.

In addition to and without limiting the rights and remedies of Landlord set forth above and elsewhere in this Lease, in the event that Tenant ceases operations from the Premises for a period in excess of thirty (30) consecutive days (excluding Permitted Closures), Landlord shall have the right at any time thereafter to terminate this Lease and recapture the Premises upon ten (10) days' prior written notice to Tenant (a "**Minimum Hours Violation Termination Notice**"). If Landlord delivers a Minimum Hours Violation Termination Notice pursuant to the terms and conditions of this paragraph, Tenant shall surrender the Premises to Landlord, in the condition required upon termination of this Lease, on the date specified by Landlord in the Minimum Hours Violation Termination Notice (the "**Minimum Hours Violation Termination Date**") and, effective as of the Minimum Hours Violation Termination Date, Base Rent and all other charges previously paid by Tenant to Landlord hereunder shall be prorated as of such date and thereafter Landlord and Tenant shall have no further obligations under this Lease except for those which survive the termination of this Lease pursuant to its terms.

(b) Operational Requirements.

(i) Tenant shall comply with the rules and regulations established by Landlord from time to time for the operation of the Center (the "**Rules and Regulations**"). The Rules and Regulations in effect on the date of this Lease are attached hereto as Exhibit D. Landlord shall, for the enforcement of the Rules and Regulations, have all remedies in this Lease provided for breach of the provisions hereof. Tenant shall not incur a charge nor shall this Lease be terminated with respect to the first two (2) violations of the Rules and Regulations occurring during any twelve (12) consecutive month period. With regard to the third and each subsequent violation of the Rules and Regulations occurring during any twelve (12) consecutive month period, Tenant shall pay Landlord as additional rental, in addition to, and not in lieu of, Landlord's other remedies, upon demand, One Hundred Dollars (\$100.00) per violation. Nothing contained in this Lease shall impose upon Landlord any obligation to enforce the Rules and Regulations or terms, covenants or conditions in any other lease against any other Retail Center tenant, and Landlord shall not be liable to Tenant for violation of the same by any other tenant, its employees, agents, visitors or licensees, provided that Landlord shall enforce the Rules and Regulations against Tenant in a non-discriminatory fashion.

(ii) Tenant shall comply with the rules and regulations regarding the naming rights of the Center ("**Naming Rights Requirements**") attached as Exhibit E (as may hereafter be modified or amended by Landlord upon notice to Tenant). Tenant's obligations under the provisions of this Section 1(e)(i) and the attached Exhibit E shall survive the expiration or earlier termination of this Lease.

(iii) Tenant shall comply with all applicable requirements of the City and County of San Francisco, the United States Department of Transportation, and other governmental entities, as the same may be amended, modified and supplemented from time to time, including those specified in Exhibit F attached hereto (the "**Governmental Requirements**").

(iv) Tenant shall not (A) permit any immoral, illegal, improper or objectionable practice to occur or be committed on the Premises, (B) make use of or allow the Premises to be used for any purposes that might invalidate or increase the rate of insurance therefor, (C) use the Premises for any purpose whatsoever which creates a nuisance or obstructs or interferes with the rights of other tenants of the Center or with Landlord's operation and use of the Center, (D) deface or injure the Center or the Premises, (E) commit or suffer any waste, or (F) install any electrical equipment that overloads utility lines.

(v) In addition, under no circumstances whatsoever shall the Premises be used in contravention of the List of Use Restrictions attached hereto as Exhibit H.

(vi) So long as Tenant's use of the Premises includes the sale or preparation of food or food-related products, Tenant shall comply with all health department and other governmental rules and regulations applicable to Tenant's operations in the Premises and shall promptly cure or otherwise eliminate all deficiencies and violations noted by the health department and other governmental authorities and take all required actions to prevent the reoccurrence of such deficiencies and violations. In addition to the foregoing, Tenant shall comply with the reasonable rules and regulations established by Landlord from time to time for tenants and occupants of the Center whose use of their respective premises includes the sale or preparation of food or food-related products (collectively, the "**Restaurant Requirements**"), provided that Landlord shall not enforce the Restaurant Requirements against Tenant in a discriminatory fashion when compared to other tenants and occupants of the Center selling or preparing food or food-related products.

(c) Center Operations. Tenant acknowledges that the Center is a metropolitan transit center located in an urban area and noise and vibration may be experienced during all hours of the day, including but not limited to Tenant's operating hours. Without limiting the foregoing, Tenant acknowledges that noise and vibration may come from buses, construction, and adjoining businesses such as, by way of example only, fitness studios, bars, restaurants, child care facilities and similar businesses. Tenant hereby agrees that no such noise and/or vibrations shall in any way constitute a constructive eviction of Tenant nor entitle Tenant to any credit against Rent or other compensation therefor.

#### Article 22 – Signage

Landlord shall have the absolute and unqualified right to determine the size, type, number and location of all signs, posters, advertisements and advertising materials and structures (collectively, "**Exterior Signage**") that are located within the Premises but readily visible to Center patrons, on the exterior of the Premises or anywhere else in the Center, and may, in its absolute discretion, limit such Exterior Signage for all tenants of the Center to a single location and a uniform style. Tenant shall not erect or display any Exterior Signage nor erect, install or project any display of merchandise, images or video displays or any other items within the Premises or in the storefront visible from the storefront, sidewalk or street or by other patrons of the Center (collectively, "**Store Display**") without first obtaining the written consent of Landlord, which consent may be withheld in Landlord's sole discretion. Prior to the execution of this Lease, Landlord has approved the design and specifications for Tenant's Exterior Signage attached hereto as Exhibit K, subject to Tenant's receipt of any necessary permits or approvals and compliance with Requirements. [**PLEASE PROVIDE SIGNAGE DESIGN AND SPECIFICATIONS FOR PREAPPROVAL**] All Exterior Signage shall comply with the Retail Center signage limitations established by Landlord from time to time (the "**Signage Limitations**"). Tenant shall obtain all necessary permits and approvals, and shall pay all costs and expenses of such erection and display. Any Exterior Signage or Store Display so erected or displayed by Tenant shall remain the property of Tenant and Tenant shall remove all such Exterior Signage or Store Display, at Tenant's sole cost and expense, upon the expiration or earlier termination of this Lease. If Tenant erects or installs any Exterior Signage or Store Display in violation of this Article 22 and does not cure such violation within twenty-four (24) hours after receipt of notice from Landlord, then, in addition to any other rights and remedies of Landlord under this Lease, at law or in equity, Tenant shall pay to Landlord upon demand the sum not to exceed One Thousand Dollars (\$1,000.00) for each day such default continues. Tenant acknowledges that failure to strictly comply with the requirements of this Article 22 will have a significant effect on the image and reputation of the Center, negatively impact the experience of patrons shopping at the Center, thereby decreasing traffic in the Center and decreasing overall sales volume of the tenants in the Center. The exact amount of the damages caused by Tenant's failure to comply with the provisions of this Article 22 are extremely difficult and impracticable to fix; therefore, the parties agree

that the above-described sums represent fair and reasonable estimates of such damages. Tenant's covenants under this Article 22 constitute material consideration for Landlord's entering into this Lease

#### Article 23 – Holding Over

If Tenant remains in possession of the Premises after the expiration or sooner termination of this Lease, all of the terms, covenants and agreements hereof shall continue to apply and bind Tenant so long as Tenant remains in possession insofar as the same are applicable, except that Tenant shall be deemed a month-to-month tenant on the same terms and provisions of this Lease except that the monthly Base Rent shall be one hundred fifty percent (150%) of the monthly Base Rent payable during the last month of the Term, prorated on a daily basis for each day that Tenant remains in possession, and Tenant shall indemnify Landlord against any and all claims, losses and liabilities for damages resulting from Tenant's failure to timely surrender possession, including, without limitation, any claims made by any succeeding tenant.

#### Article 24 – Estoppels

Tenant shall, at any time and from time to time, upon ten (10) days prior written request by Landlord, execute, acknowledge and deliver to Landlord a certificate certifying: (a) that Tenant has accepted the Premises (or, if Tenant has not done so, that Tenant has not accepted the Premises, and specifying the reasons therefor); (b) the Commencement Date and Expiration Date; (c) whether there are then existing any defaults by Landlord in the performance of its obligations under this Lease (and, if so, specifying the same); (d) that this Lease is unmodified and in full force and effect (or, if there have been modifications, that this Lease is in full force and effect, as modified, and stating the date and nature of each modification); (e) the capacity of the person executing such certificate, and that such person is duly authorized to execute the same on behalf of Tenant; (f) the date to which the Base Rent, Percentage Rent and other sums payable hereunder have been paid; (g) that no notice has been received by Tenant of any default which has not been cured, except as to defaults specified in the certificate; (h) the amount of any security deposit and/or prepaid rent; and (i) such other matters as may be reasonably requested by Landlord. Any such certificate may be relied on by any prospective purchaser, mortgagee or beneficiary under any deed of trust affecting the Center or any part thereof. Tenant shall indemnify and hold Landlord harmless from and against all costs, damages, expenses, liabilities and fees including, without limitation, reasonable attorneys' fees and any consequential damages or lost profits, arising from or in any way related to or connected with Tenant's failure to deliver any such certificate within the time specified in this Article 24.

#### Article 25 – Financial Statements

Tenant represents that it has provided Landlord with a true, complete and accurate copy of Tenant's most recent financial statements which are free of material error. Tenant acknowledges that Landlord has relied on such financial statements in entering into this Lease and any breach of Tenant's foregoing representation shall constitute an immediate Event of Default hereunder. Upon request from time to time, Tenant agrees to provide to Landlord, within ten (10) days of written request, current financial statements for Tenant, dated no earlier than one (1) year prior to such request, certified as accurate by a financial officer of Tenant or, if available, audited financial statements prepared by an independent certified public accountant with copies of the auditor's statement. If any Guaranty is executed in connection with this Lease, Tenant also agrees to deliver to Landlord, within ten (10) days of written request, current financial statements of the Guarantor in a form consistent with the above criteria.

#### Article 26 – Miscellaneous Provisions

(a) Attorneys' Fees. If either Landlord or Tenant institutes any arbitration or any action or proceeding in court to enforce any provision or provisions hereof, or for damages by reason of any default

under this Lease, or for a declaration of such party's or parties' rights or obligations hereunder, or for any other judicial remedies, the prevailing party or parties shall be entitled to receive from the losing party or parties such amount as the arbitrator or court may adjudge to be reasonable attorneys' fees for the services rendered to the party or parties prevailing in any such action or proceeding.

(b) Notices. Whenever in this Lease it is required or permitted that notice or demand be given or served by Landlord or Tenant to or on the other, such notice or demand shall be in writing and shall be given or served by personal service, certified or registered mail, reputable overnight delivery service which provides written evidence of delivery, electronic mail or facsimile transmission during normal business hours and addressed as set forth in the Basic Lease Information. Notices or demands so served shall be deemed to be given or served (i) on the date of delivery or first attempted delivery, if delivered by personal service, by certified or registered mail return receipt requested, postage prepaid or by any such overnight delivery service, charges billed to the sending party or (ii) on the date of transmission as shown by the sending party's transmittal record, if sent by facsimile transmission or electronic mail during normal business hours (or on the next business day if sent after normal business hours), so long as a duplicate notice or demand is sent by any other method permitted by this Section 26(b) within one (1) business day following such transmission date. Either party may change its address for notices or demands by written notice delivered in accordance with this Section 26(b).

(c) Successors and Assigns. All covenants, promises, conditions, representations and agreements herein contained shall be binding upon and inure to the parties hereto and their respective heirs, executors, administrators, legal representatives, successors and assigns (subject to the limitations on transfer set forth in Article 17 hereof).

(d) Waiver. The failure of Landlord or Tenant to insist upon strict performance by the other party of any of the covenants, conditions and agreements of this Lease shall not be deemed a waiver of any of Landlord's or Tenant's rights or remedies and shall not be deemed a waiver of any subsequent breach or default by the other party of any of the covenants, conditions and agreements of this Lease.

(e) Interpretation. It is the parties' intention to create only the relationship of landlord and tenant, and no provision hereof, or act of either party hereunder, shall be construed as creating the relationship of principal and agent, partnership, joint venture or enterprise.

(f) No Right of Relocation. Tenant acknowledges that it will not be a displaced person at the time this Lease is terminated or expires by its own terms, and Tenant fully RELEASES, WAIVES AND DISCHARGES forever any and all claims, and covenants not to file any action, against Landlord or any Landlord Entity, under any laws, including, without limitation, any and all claims for relocation benefits or assistance under federal and state relocation assistance laws (including, but not limited to, California Government Code Sections 7260 et seq.). Without limiting the provisions of Article 17 hereof, Tenant shall cause any transferee, assignee, sublessee, licensee or concessionaire of or under this Lease (each a "**Transferee**") expressly to waive any claim of entitlement to any and all relocation assistance and benefits in connection with this Lease. Tenant shall indemnify, protect, defend and hold harmless Landlord and the other Landlord Entities from and against any and all claims for relocation assistance or benefits by any such Transferee.

(g) Waiver of Redemption. Tenant expressly waives any and all rights of redemption granted by or under any present or future laws if Tenant is evicted or dispossessed for any cause, or if Landlord obtains possession of the Premises by reason of the violation by Tenant of any of the covenants and conditions of this Lease or otherwise. The rights given to Landlord herein are in addition to any rights that may be given to Landlord by any statute or otherwise.

(h) OFAC. Tenant represents and warrants to Landlord that it is currently in compliance with, and shall at all times during the Term remain in compliance with, the applicable regulations of the

Office of Foreign Asset Control (“OFAC”) of the Department of the Treasury (including but not limited to those named on OFAC’s Specially Designated and Blocked Persons List) and any statute, executive order (including the September 24, 2001, Executive Order Blocking Property and Prohibiting Transactions with Persons Who Commit, Threaten to Commit, or Support Terrorism), or other governmental action relating thereto.

(i) Brokers. Landlord and Tenant warrant and represent that they have not had negotiations with or dealt with any realtor, broker, agent or other person or entity in connection with the negotiation and execution of this Lease, except Landlord’s Broker, if any, as set forth in the Basic Lease Information, and each shall pay and hold the other harmless from any cost, expense or liability (including cost of suit and reasonable attorneys’ fees) for any compensation, commissions or charges claimed by any other realtor, broker, agent or other person or entity with respect to this Lease and the negotiation thereof and arising out of the actions of the indemnifying party.

(j) Recording. This Lease shall not be recorded.

(k) Force Majeure. If either party is delayed or hindered in or prevented from the performance of any act required hereunder by reason of strikes, lockouts, labor troubles, inability to procure materials, failure of power, restrictive governmental laws or regulations, riots, insurrection, war or other reason of a like nature not the fault of or within the reasonable control of the party so delayed, hindered or prevented from performing, then performance of such act shall be excused for the period of delay and the period for the performance of any such act shall be extended for a period equivalent to the period of such delay, provided the affected party gives the other party notice within thirty (30) days of the event causing the prevention, delay or stoppage. The provisions of this Section 26(k) shall not operate to excuse Tenant from the prompt payment of any installment of the Base Rent or Percentage Rent or any other payments required by the terms of this Lease.

(l) Accord and Satisfaction. No payment by Tenant or receipt by Landlord of a lesser amount than the Rent herein stipulated shall be deemed to be other than on account of the Rent otherwise payable hereunder, nor shall any endorsement or statement on any check or any letter accompanying any check or payment as Rent be deemed an accord and satisfaction, and Landlord may accept such check or payment without prejudice to Landlord’s rights to recover the balance of such Rent or pursue any other remedy provided in this Lease.

(m) Construction of Lease. Tenant has read and understands all parts of this Lease. In the construction and interpretation of the terms of this Lease, the rule of construction that a document is to be construed most strictly against the party who prepared the same shall not be applied, it being agreed that both parties hereto have participated in the preparation of the final form of this Lease.

(n) Headings. Captions used herein are for convenience and reference only, and shall in no way be deemed to explain, modify, amplify or aid in the interpretation, construction or meaning of the provisions of this Lease. The use of the terms “hereof,” “hereunder,” and “herein” shall refer to this Lease as a whole, inclusive of the exhibits, except when noted otherwise. The use of the masculine or neuter genders herein shall include the masculine, feminine and neuter genders. The singular form shall include the plural when the context so requires.

(o) Severability. If any provision of this Lease or any term, paragraph, sentence, clause, phrase or word appearing herein collectively, a “**provision**”) is judicially or administratively held to be invalid or unenforceable for any reason, such holding shall not be deemed to affect, alter, modify or impair in any manner any other provision appearing herein and this Lease shall remain in full force and effect without the invalid or unenforceable provision. All charges, fees and other payments are deemed “additional rental” herein for the purpose of enforcing Landlord’s remedies, and shall not be construed as “rent” in the event of imposition of rent controls.

(p) Objection to Statements. Tenant's failure to object to any statement, invoice or billing rendered by Landlord within a period of six (6) months after receipt thereof shall constitute Tenant's acquiescence with respect thereto and shall render such statement, invoice or billing an account stated between Landlord and Tenant.

(q) Limitations on Liability. All liability of Landlord under this Lease shall be limited to its interest in the Center and any judgments rendered against Landlord shall be satisfied solely out of the proceeds of sale of its interest in the Center and/or proceeds of insurance which have been received by Landlord. No personal judgment shall lie against Landlord upon extinguishment of its interest in the Center and no judgment so rendered shall give rise to any right of execution or levy against Landlord's assets. The foregoing provisions are not designed to relieve Landlord from the performance of any of Landlord's obligations under this Lease, but only to limit the personal liability of Landlord in case of recovery of a judgment against Landlord; nor shall the foregoing be deemed to limit Tenant's rights to obtain injunctive relief or specific performance or to avail itself of any other right or remedy at law or under this Lease. In addition to the foregoing, none of the other Landlord Entities shall be personally liable to Tenant, its successors and assigns, in the event of any default or breach by Landlord or for any amount which may become due to Tenant, its successors and assigns, or for any obligation of Landlord under this Lease.

(r) Execution of Documents. Tenant shall reimburse Landlord upon demand for all administrative and legal costs and expenses associated with the review, preparation and/or processing of any document executed at Tenant's request pursuant to or in connection with this Lease.

(s) Corporate or Partnership Tenant. If Tenant is or will be a corporation or partnership, each of the persons executing this Lease on behalf of Tenant hereby covenants and warrants that Tenant is a duly authorized and existing entity, that Tenant is authorized to do business in the State of California; that Tenant has full power and authority to enter into this Lease; and that each and all of the persons executing this Lease on behalf of Tenant is duly authorized to do so. Upon Landlord's request, Tenant shall provide Landlord with evidence reasonably satisfactory to Landlord confirming the foregoing covenants and warranties.

(t) Entire Agreement. This Lease and Exhibits A, B, C, D, E, F, G, H, I, J and K attached hereto, the Addendum to Salesforce Transit Center Lease - Option to Extend Term attached hereto, each of which is incorporated herein by this reference, constitute the entire agreement between the parties with respect to the Premises. No amendment, modification of or supplement to this Lease shall be effective unless in writing and executed by Landlord and Tenant.

(u) Time of Essence. Time is of the essence of this Lease and of all provisions hereof, except with respect to the delivery of possession of the Premises at the commencement of the Term.

(v) Governing Law. This Lease shall be construed and enforced in accordance with the laws of the State of California.

(w) Joint and Several Liability. If Tenant consists of more than one individual, partnership, corporation or other legal entity, then all such individuals, partnerships, corporations and/or entities shall be jointly and severally liable as Tenant hereunder.

(x) No Light, Air or Access Rights. Nothing herein contained shall be construed to grant to or create in Tenant any easements of light, air or access, Tenant's rights being limited to the use and occupancy of the Premises and the license to use the Common Areas as they may exist from time to time, all subject to the terms, covenants and conditions of this Lease.

(y) Survival. Tenant's obligation to pay the Rent and all other charges due hereunder and applicable to the Term and all indemnities contained herein shall survive the expiration of this Lease.

THE SUBMISSION OF THIS LEASE FOR EXAMINATION DOES NOT CONSTITUTE A RESERVATION OF, OR OPTION FOR, THE PREMISES OR ANY OTHER SPACE WITHIN THE CENTER, AND SHALL VEST NO RIGHT IN TENANT. THIS LEASE SHALL BECOME EFFECTIVE AS A LEASE ONLY UPON EXECUTION AND DELIVERY BY ALL PARTIES HERETO. NOTWITHSTANDING ANYTHING TO THE CONTRARY CONTAINED IN THIS LEASE, TENANT ACKNOWLEDGES AND AGREES THAT NO OFFICER OR EMPLOYEE OF LANDLORD HAS AUTHORITY TO BIND LANDLORD TO THIS LEASE UNLESS AND UNTIL LANDLORD'S BOARD OF DIRECTORS, OR THE APPLICABLE COMMITTEE OF LANDLORD'S BOARD OF DIRECTORS, SHALL HAVE APPROVED THIS LEASE BY APPROPRIATE ACTION AND AUTHORIZED THE TRANSACTIONS CONTEMPLATED HEREBY. THEREFORE, ANY OBLIGATIONS OR LIABILITIES OF LANDLORD HEREUNDER ARE CONTINGENT UPON SUCH APPROVAL BY LANDLORD'S BOARD OF DIRECTORS, OR THE APPLICABLE COMMITTEE OF LANDLORD'S BOARD OF DIRECTORS, IN THEIR RESPECTIVE SOLE AND ABSOLUTE DISCRETION, AND IN ACCORDANCE WITH ALL APPLICABLE LAWS. APPROVAL OF THIS LEASE BY ANY AGENT OR REPRESENTATIVE OF LANDLORD SHALL NOT BE DEEMED TO IMPLY THAT EITHER OF THE FOREGOING APPROVALS BY LANDLORD'S BOARD OF DIRECTORS, OR THE APPLICABLE COMMITTEE OF LANDLORD'S BOARD OF DIRECTORS SHALL BE OBTAINED, NOR WILL ANY SUCH APPROVAL BY ANY AGENT OR REPRESENTATIVE OF LANDLORD CREATE ANY BINDING OBLIGATIONS ON LANDLORD.

[BALANCE OF THIS PAGE INTENTIONALLY LEFT BLANK – SIGNATURE PAGE FOLLOWS.]

IN WITNESS WHEREOF the parties hereto have executed this Lease as of the dates set forth beneath each party's signature below.

LANDLORD

TENANT

TRANSBAY JOINT POWERS AUTHORITY

Spring Fertility Management LLC  
a \_\_\_\_\_

By: \_\_\_\_\_

By: \_\_\_\_\_

Name: \_\_\_\_\_

Name: \_\_\_\_\_

Its: \_\_\_\_\_

Its: \_\_\_\_\_

Date: \_\_\_\_\_, 20\_\_

Date: \_\_\_\_\_, 20\_\_

APPROVED AS TO FORM.

By: \_\_\_\_\_  
Legal counsel, TJPA

Transbay Joint Powers Authority Board of Directors

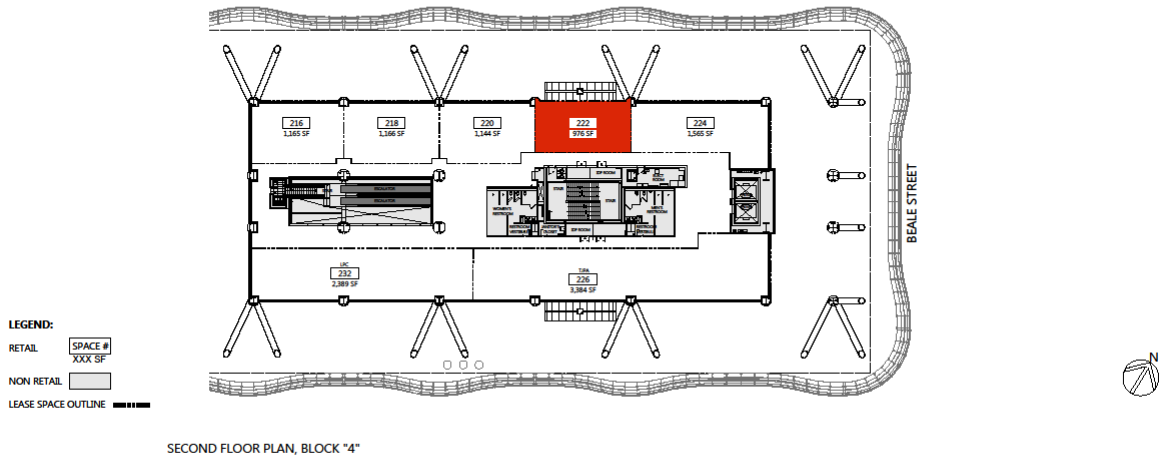
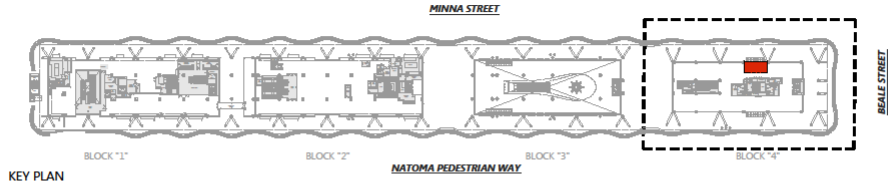
Resolution No.: \_\_\_\_\_

Adopted: \_\_\_\_\_

Attest:  
\_\_\_\_\_  
Secretary, TJPA Board

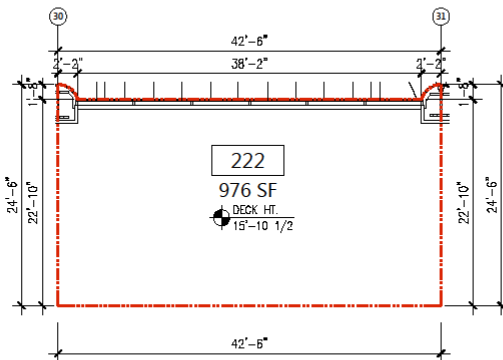


**EXHIBIT A**  
**SITE PLAN OF PREMISES**



salesforce TRANSIT CENTER

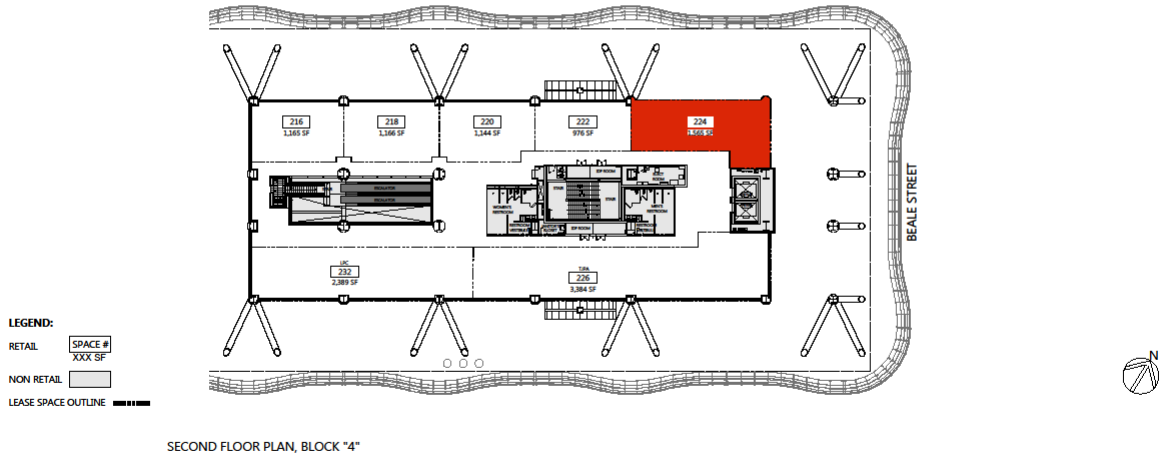
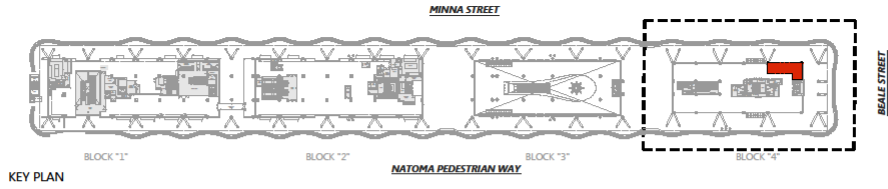
TENANT SPACE: 222 | AREA: 976 SF. | DATE: OCT 13, 2017



salesforce TRANSIT CENTER

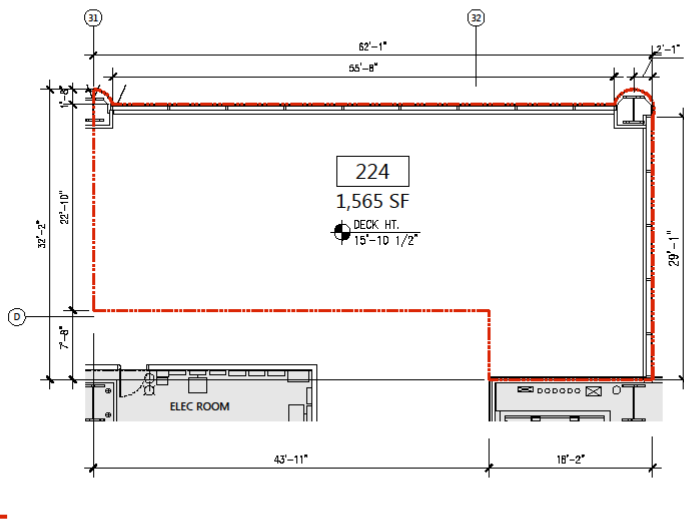
TENANT SPACE: 222 | AREA: 976 SF. | DATE: OCT 13, 2017





salesforce TRANSIT CENTER

TENANT SPACE: 224 | AREA: 1,565 SF. | DATE: OCT 13, 2017



salesforce TRANSIT CENTER

TENANT SPACE: 224 | AREA: 1,565 SF. | DATE: OCT 13, 2017



## EXHIBIT B

### WORK LETTER

This Work Letter shall set forth the terms and conditions relating to the construction of the Premises. This Work Letter is essentially organized chronologically and addresses the issues of the construction of the Premises, in sequence, as such issues will arise during the actual construction of the Premises. All capitalized terms used but not defined herein shall have the meanings given such terms in the Lease. All references in this Work Letter to Articles or Sections of “the Lease” shall mean the relevant portion of the Retail Lease Agreement to which this Work Letter is attached and of which this Work Letter forms a part, and all references in this Work Letter to Sections of “this Work Letter” shall mean the relevant portion of this Work Letter.

### SECTION 1

#### LANDLORD'S INITIAL CONSTRUCTION IN THE PREMISES

1.1 Base Shell and Core of the Premises as Constructed by Landlord. Landlord has constructed, or shall construct, at its sole cost and expense, (a) the base, shell and core (i) of the Premises and (ii) the Center in which the Premises is located (collectively, the “**Base, Shell and Core**”) in accordance with the plans and specifications for the Base, Shell and Core and on an unoccupied basis and (b) to the extent not already included in the Base, Shell and Core, the work specified in Schedule 1 attached hereto and incorporated herein by this reference (excluding any work noted therein as “By Tenant” or similar notation, the “**Additional Work**” and together with the Base, Shell and Core, the “**Landlord Work**”). As of the Lease Date, Landlord has provided Tenant with a copy of the plans and specifications for the Base, Shell and Core. For purposes of this Lease, including but not limited to for purposes of determining the Commencement Date (as set forth in the Summary) the Landlord Work shall be deemed to be “Substantially Completed” when it has been completed in accordance with the plans and specifications for the same, on an unoccupied basis, except for finishing details, minor omissions, decorations and mechanical adjustments of the type normally found on an architectural “punch list” which would not prevent Tenant from commencing construction of the Tenant Improvements in the Premises (which punch list items shall be completed within a reasonable period of time). (The definition of Substantially Completed shall also define the terms “**Substantial Completion**” and “**Substantially Complete**”.) Upon Landlord’s Substantial Completion of the Landlord Work and delivery of the Premises to Tenant, the renovations to the improvements in the Premises shall be designed and constructed by Tenant pursuant to this Work Letter.

### SECTION 2

#### TENANT IMPROVEMENTS

2.1 Improvement Allowance. Tenant shall be entitled to a one-time improvement allowance (the “**Improvement Allowance**”) in the amount of Fifty and No/100 Dollars (\$50.00) per usable square foot of the Premises for the costs relating to the initial design and construction of the Tenant Improvements (as defined in Section 3.3 below) and for the other Improvement Allowance Items described in Section 2.2 below. In no event shall Landlord be obligated to make disbursements pursuant to this Work Letter in a total amount which exceeds the Improvement Allowance and in no event shall Tenant be entitled to any credit for any unused portion of the Improvement Allowance not used by Tenant prior to the first (1<sup>st</sup>) anniversary of the Commencement Date.

2.2 Disbursement of the Improvement Allowance. Except as otherwise set forth in this Work Letter, the Improvement Allowance shall be disbursed by Landlord pursuant to the process set forth in Section 2.2.1 below for costs related to the construction of the Tenant Improvements and for the following items and costs (collectively, the “**Improvement Allowance Items**”): (a) payment of the fees

of the “Architect” and the “Engineers,” as those terms are defined in Section 3.1 of this Work Letter, and payment of the fees incurred by, and the cost of documents and materials supplied by, Landlord and Landlord’s consultants in connection with the preparation and review of the Construction Drawings (as defined in Section 3.1 below); (b) the cost of permits and construction supervision fees; (c) installing cabling in the Premises; (d) the cost of any changes in the Base, Shell and Core required by the Construction Drawings; (e) the cost to cause the Premises to comply with all Requirements, including, without limitation, Title 24 and the ADA; and (f) the “Landlord Coordination Fee”, as that term is defined in Section 4.3 of this Work Letter. However, in no event shall more than Twelve and No/100 Dollars (\$12.00) per usable square foot of the Improvement Allowance be used for the items described in (a), (b) and (c) above and any additional amount incurred as a result of (a), (b) or (c) above shall be paid by Tenant.

2.2.1 Disbursement. Promptly following completion of the Tenant Improvements, Tenant shall deliver to Landlord: (a) a request for payment of the Contractor (as defined in Section 4.1 below), approved by Tenant, in a form to be provided by Landlord; (b) invoices from all of Tenant’s Agents (as defined in Section 4.2 below) for labor rendered and materials delivered to the Premises; (c) executed unconditional mechanic’s lien releases from all of Tenant’s Agents which shall comply with the appropriate provisions of California Civil Code Section 8136 and Section 8138; and (d) all other information reasonably requested by Landlord. Tenant’s request for payment shall be deemed Tenant’s acceptance and approval of the work furnished and/or the materials supplied as set forth in Tenant’s payment request. Thereafter, provided that Tenant has opened for business in the Premises and is continuously operating its business at the Premises, subject to the terms and provisions of the Lease, Landlord shall deliver a check to Tenant in payment of the lesser of (i) the amounts so requested by Tenant, and (ii) the remaining available portion of the Improvement Allowance, provided that Landlord does not dispute any request for payment based on non-compliance of any work with the Approved Working Drawings (as defined in Section 3.4 below), or due to any substandard work, or for any other reason. Landlord’s payment of such amounts shall not be deemed Landlord’s approval or acceptance of the work furnished or materials supplied as set forth in Tenant’s payment request.

2.2.2 Other Terms. Landlord shall only be obligated to make disbursements from the Improvement Allowance to the extent costs are incurred by Tenant for Improvement Allowance Items. All Tenant Improvements shall be deemed Landlord’s property. If the total estimated cost of Improvement Allowance Items exceeds the Improvement Allowance, Tenant shall be required to first fund such excess prior to the commencement of Landlord’s obligation to fund the Improvement Allowance and Landlord may require reasonable evidence that Tenant has funded such excess prior to Landlord’s disbursement of the Improvement Allowance. Tenant shall pay for all costs and expenses associated with the Tenant Improvements when and as required by Tenant’s Contractor (subject to Landlord’s payment of the Improvement Allowance when and as required under the terms of this Work Letter).

2.3 Tenant Design Guidelines. Landlord has established specifications (the “**Tenant Design Guidelines**”) for the Center to be used in the construction of any improvements in the Premises, which Tenant Design Guidelines, as the same may be amended and modified from time to time, are available upon request. All Tenant Improvements shall adhere to the Tenant Design Guidelines.

### SECTION 3 CONSTRUCTION DRAWINGS

3.1 Final Space Plan. Prior to the execution of this Lease, Landlord and Tenant have approved a detailed space plan for the construction of certain improvements in the Premises, which space plan is attached hereto as Schedule 2 (the “**Final Space Plan**”).

3.2 Selection of Architect/Working Drawings. Tenant shall retain an architect reasonably approved by Landlord (the “**Architect**”) to prepare the Working Drawings (as defined below). Tenant shall also retain the engineering consultants designated by Landlord (the “**Engineer**”) to prepare all plans and engineering working drawings relating to the structural, mechanical, electrical, plumbing, HVAC and lifesafety work of the Tenant Improvements. The plans and drawings to be prepared by Architect and the Engineers hereunder shall be known collectively as the “**Working Drawings.**” All Working Drawings shall comply with the drawing format and specifications as reasonably determined by Landlord, and shall be subject to Landlord's reasonable approval in accordance with the design review process (the “**Design Review Process**”) established by Landlord for the Center, which Design Review Process, as the same may be amended and modified from time to time, is available upon request. Tenant and Architect shall verify, in the field, the dimensions and conditions as shown on the relevant portions of the base building plans, and Tenant and Architect shall be solely responsible for the same, and Landlord shall have no responsibility in connection therewith.

3.3 Approved Working Drawings. Tenant shall comply with the submission requirements set forth in the Design Review Process. Without limiting the foregoing, as soon as reasonably possible following the mutual execution and delivery of the Lease and delivery of the Landlord Work Plans to Tenant in accordance with Section 1.1 of this Work Letter but in no event later than forty-five (45) days following the mutual execution and delivery of the Lease and delivery of the Landlord Work Plans to Tenant in accordance with Section 1.1 of this Work Letter, Tenant shall submit the documents, specifications and other information required as part of the “Schematic Design Submittal” (as defined in the Design Review Process) to Landlord for Landlord’s review and comment in accordance with the Design Review Process. Promptly following receipt of Landlord’s comments to the Schematic Design Submittal but in no event later than the date that is sixty (60) days following the mutual execution and delivery of the Lease and delivery of the Landlord Work Plans to Tenant in accordance with Section 1.1 of this Work Letter, Tenant shall submit all construction documents, project specifications, bidding documents and other information required as part of Tenant’s “95% Construction Drawings Submittal” (as defined in the Design Review Process) to Landlord for Landlord's approval in accordance with the Design Review Process. The final set of architectural and engineering drawings for the Premises approved by Landlord in accordance with the Design Review Process (including but not limited to any 100% construction documents prepared on the basis of the 95% Construction Drawings Submittal and incorporating Landlord’s comments thereto, if any) are collectively referred to herein as the “**Approved Working Drawings.**” The tenant improvements shown on the Approved Working Drawings shall be referred to herein as the “**Tenant Improvements.**” The Final Space Plan, Working Drawings and Approved Working Drawings shall be collectively referred to herein as, the “**Construction Drawings.**” No changes, modifications or alterations in the Construction Drawings may be made without the prior written consent of Landlord, which consent shall not be unreasonably withheld. Landlord's review of the Construction Drawings shall be for its sole purpose and shall not imply Landlord's review of the same, or obligate Landlord to review the same, for quality, design, compliance with applicable Requirements or other like matters. Accordingly, notwithstanding that any Construction Drawings are reviewed by Landlord or its space planner, architect, engineers and consultants, and notwithstanding any advice or assistance which may be rendered to Tenant by Landlord or Landlord's space planner, architect, engineers, and consultants, Landlord shall have no liability whatsoever in connection therewith and shall not be responsible for any omissions or errors contained in the Construction Drawings.

3.4 Permits. Tenant shall submit the Approved Working Drawings to the appropriate municipal authorities for all applicable building permits necessary to allow Contractor (as defined in Section 4.1 below) to commence and fully complete the construction of the Tenant Improvements (the “**Permits**”) promptly following Landlord’s approval of the same (but in no event later than ten (10) business days following such approval) and shall use good faith diligent efforts to obtain such Permits. Commencement of construction of the Tenant Improvements shall not occur until Landlord has approved the Approved Working Drawings and the Permits for the same have been issued.

3.5 Restrooms. The restroom plan for the Center is attached to this Work Letter as Schedule 3 (the “**Restroom Plan**”). Tenant acknowledges that (a) if the Premises is located within the area shaded in green in the attached Restroom Plan, Tenant is required to construct its own restroom facilities within the Premises as part of the Tenant Improvements and (b) if the Premises is located within the areas shaded in blue or orange in the attached Restroom Plan, Tenant may use the common area restroom facilities designated for the Premises in the attached Restroom Plan and is not be required to construct its own restroom facilities in the Premises as part of the Tenant Improvements.

## SECTION 4

### CONSTRUCTION OF THE TENANT IMPROVEMENTS

4.1 Contractor. A general contractor shall be retained by the Tenant to construct the Tenant Improvements. Such general contractor (“**Contractor**”) shall be selected by the Tenant and approved by Landlord.

4.2 Tenant's Agents. All subcontractors, laborers, materialmen, and suppliers used by the Tenant (such subcontractors, laborers, materialmen, and suppliers, and the Contractor to be known collectively as “**Tenant's Agents**”) must be approved in writing by Landlord, which approval shall not be unreasonably withheld or delayed. If Landlord does not approve any of the Tenant's proposed subcontractors, laborers, materialmen or suppliers, the Tenant shall submit other proposed subcontractors, laborers, materialmen or suppliers for Landlord's written approval. Notwithstanding the foregoing, the Tenant shall be required to utilize subcontractors designated by Landlord for any mechanical, electrical, plumbing, life-safety, sprinkler, structural and air-balancing work. Tenant shall comply with the provisions of Section 7.3 of the Lease with regard to the selection and use of any Tenant's Agents.

#### 4.3 Construction of Tenant Improvements by Contractor.

4.3.1 Construction Matters. The Tenant shall independently retain, in accordance with Section 4.1 above, Contractor to construct the Tenant Improvements in accordance with the Approved Working Drawings and pursuant to all Requirements. The Improvement Allowance shall be charged a logistical coordination fee (the “**Landlord Coordination Fee**”) to Landlord in an amount equal to (a) three percent (3%) of the total amount of the construction contract and general conditions between the Tenant and the Contractor if Tenant uses Landlord's asset manager's construction team as project manager for construction of the Tenant Improvements (the “**Lincoln Construction Team**”) and (b) one and one half percent (1.5%) of the total amount of the construction contract and general conditions between the Tenant and the Contractor if Tenant uses any project manager other than the Lincoln Construction Team as project manager for construction of the Tenant Improvements. In addition, Tenant shall reimburse Landlord for any actual, documented and reasonable costs and expenses incurred by Landlord in connection with the Tenant Improvements (including any reasonable, out-of-pocket architects' and engineering fees and costs incurred by Landlord in connection with the review and approval of Tenant's plans and specifications). Tenant, the Contractor and all of Tenant's Agents shall abide by Landlord's construction rules and regulations (which may include, without limitation, a requirement that any work that Landlord determines may be noisy, may cause vibrations or may otherwise disrupt other occupants of the Project must be performed on an after-hours basis) and, to the extent any such work adjoins or would otherwise affect in any way any facilities or operations of any transit agency or rail operator at the Center, the rules, regulations and procedures promulgated from time to time by the applicable transit agency or rail operator. Tenant shall cause the Tenant Improvements to be completed at Tenant's sole cost and expense (subject to the Improvement Allowance), in compliance with all applicable Requirements. In performing the work of any such Alterations, Tenant shall have the work performed in such manner as not to obstruct access to the Center or any Common Areas for any other tenant or user of the Center, and as not to unreasonably interfere, in any manner whatsoever, with

the facilities (including installed equipment, signage and safety equipment) and operations of Landlord or any other tenant, user or occupant of the Center (including any transit agency or rail operator).

4.3.2 Construction Schedule. Tenant shall cause the Tenant Improvements to be completed no later than the date that is three hundred sixty-five (365) days following the mutual execution of the Lease. If Tenant fails to timely complete the Tenant Improvements by the date specified in the first sentence of this Section 4.3.2, then in addition to Landlord's available rights and remedies, Tenant shall pay to Landlord a "**Construction Late Charge**" in the amount of Four Thousand Three Hundred Eighteen and 75/100 Dollars (\$4,318.75) for each week or portion thereof that said failure continues. Tenant agrees that such Construction Late Charge shall not constitute damages, and that neither Tenant's payment of such Construction Late Charge nor Landlord's acceptance of such payment shall result in a cure of any default under this Lease, or waiver by Landlord of any default under this Lease. Payment of the Construction Late Charge shall be due on the same date that the next Rent payment is due. Landlord and Tenant agree that the Construction Late Charge represents a reasonable estimate of Landlord's costs and expenses and is fair compensation to Landlord for its loss resulting from Tenant's late payment.

4.4 Indemnification & Insurance.

4.4.1 Indemnity. Tenant's indemnity of Landlord and each Landlord Entity as set forth in Section 11.2 of the Lease shall also apply with respect to any and all costs, losses, damages, injuries and liabilities related in any way to any act or omission of Tenant or Tenant's Agents.

4.4.2 Requirements of Tenant's Agents. Each of Tenant's Agents shall guarantee to Tenant and for the benefit of Landlord that the portion of the Tenant Improvements for which it is responsible shall be free from any defects in workmanship and materials for a period of not less than one (1) year from the date of completion thereof. All such warranties or guarantees as to materials or workmanship of or with respect to the Tenant Improvements shall be contained in the contract or subcontract and shall be written such that such guarantees or warranties shall inure to the benefit of both Landlord and Tenant, as their respective interests may appear, and can be directly enforced by either. Tenant covenants to give to Landlord any assignment or other assurances which may be necessary to effect such right of direct enforcement.

4.4.3 Insurance. During construction of the Tenant Improvements, all of Tenant's Agents shall carry the insurance coverage required in the Insurance Requirements attached as Exhibit C of the Lease. In the event that the Tenant Improvements are damaged by any cause during the course of the construction thereof, Tenant shall immediately repair the same at Tenant's sole cost and expense. Landlord may, in its discretion, require Tenant to obtain, from a surety reasonably approved by Landlord, an indemnity bond or some alternate form of security satisfactory to Landlord in an amount sufficient to ensure the lien-free completion of the Tenant Improvements and naming Tenant as the principal and Landlord as the obligee.

## SECTION 5

### MISCELLANEOUS

5.1 Tenant's Representative. The Tenant has designated \_\_\_\_\_ [*insert name and contact information of Tenant's representative*] as its sole representative with respect to the matters set forth in this Work Letter, who, until further notice to Landlord, shall have full authority and responsibility to act on behalf of the Tenant as required in this Work Letter.

5.2 Landlord's Representative. Prior to commencement of construction of Tenant Improvements, Landlord shall designate a representative with respect to the matters set forth in this Work

Letter, who, until further notice to the Tenant, shall have full authority and responsibility to act on behalf of the Landlord as required in this Work Letter.

5.3 Time of the Essence in This Work Letter. Unless otherwise indicated, all references herein to a "number of days" shall mean and refer to calendar days.

DRAFT



**SCHEDULE 1 TO WORK LETTER**

**ADDITIONAL WORK**

DRAFT

DRAFT

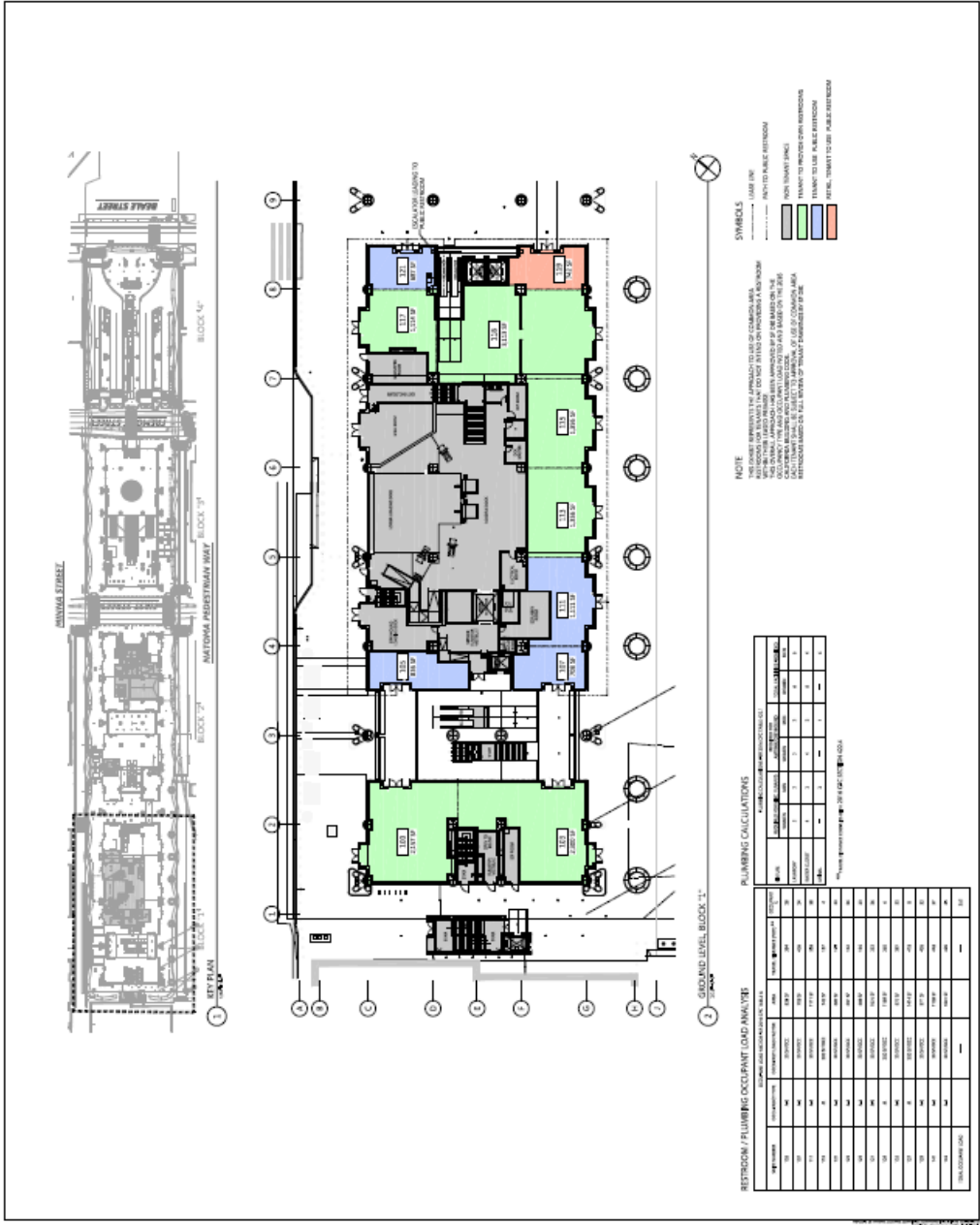
**SCHEDULE 2 TO WORK LETTER**

**FINAL SPACE PLAN**

DRAFT

# SCHEDULE 3 TO WORK LETTER

## RESTROOM PLAN



**NOTE**  
 THIS DRAWING IS FOR INFORMATION ONLY. IT IS NOT TO BE USED FOR CONSTRUCTION. THE CONTRACTOR SHALL VERIFY ALL DIMENSIONS AND CONDITIONS ON THE JOB SITE. THE CONTRACTOR SHALL BE RESPONSIBLE FOR OBTAINING ALL NECESSARY PERMITS AND APPROVALS FROM THE LOCAL HEALTH DEPARTMENT AND OTHER AGENCIES. THE CONTRACTOR SHALL BE RESPONSIBLE FOR OBTAINING ALL NECESSARY PERMITS AND APPROVALS FROM THE LOCAL HEALTH DEPARTMENT AND OTHER AGENCIES. THE CONTRACTOR SHALL BE RESPONSIBLE FOR OBTAINING ALL NECESSARY PERMITS AND APPROVALS FROM THE LOCAL HEALTH DEPARTMENT AND OTHER AGENCIES.

**SYMBOLS**  
 - - - - - MEN'S PUBLIC RESTROOM  
 - - - - - WOMEN'S PUBLIC RESTROOM  
 - - - - - SINK  
 - - - - - TOTAL TOILET TO USE PUBLIC RESTROOM

**PLUMBING CALCULATIONS**

NO.	DESCRIPTION	UNIT	PLUMBING CALCULATION	PLUMBING CALCULATION	PLUMBING CALCULATION
1	RESTROOM	1	1	1	1
2	RESTROOM	1	1	1	1
3	RESTROOM	1	1	1	1
4	RESTROOM	1	1	1	1
5	RESTROOM	1	1	1	1
6	RESTROOM	1	1	1	1
7	RESTROOM	1	1	1	1
8	RESTROOM	1	1	1	1
9	RESTROOM	1	1	1	1
10	RESTROOM	1	1	1	1
11	RESTROOM	1	1	1	1
12	RESTROOM	1	1	1	1
13	RESTROOM	1	1	1	1
14	RESTROOM	1	1	1	1
15	RESTROOM	1	1	1	1
16	RESTROOM	1	1	1	1
17	RESTROOM	1	1	1	1
18	RESTROOM	1	1	1	1
19	RESTROOM	1	1	1	1
20	RESTROOM	1	1	1	1
21	RESTROOM	1	1	1	1
22	RESTROOM	1	1	1	1
23	RESTROOM	1	1	1	1
24	RESTROOM	1	1	1	1
25	RESTROOM	1	1	1	1
26	RESTROOM	1	1	1	1
27	RESTROOM	1	1	1	1
28	RESTROOM	1	1	1	1
29	RESTROOM	1	1	1	1
30	RESTROOM	1	1	1	1
31	RESTROOM	1	1	1	1
32	RESTROOM	1	1	1	1
33	RESTROOM	1	1	1	1
34	RESTROOM	1	1	1	1
35	RESTROOM	1	1	1	1
36	RESTROOM	1	1	1	1
37	RESTROOM	1	1	1	1
38	RESTROOM	1	1	1	1
39	RESTROOM	1	1	1	1
40	RESTROOM	1	1	1	1
41	RESTROOM	1	1	1	1
42	RESTROOM	1	1	1	1
43	RESTROOM	1	1	1	1
44	RESTROOM	1	1	1	1
45	RESTROOM	1	1	1	1
46	RESTROOM	1	1	1	1
47	RESTROOM	1	1	1	1
48	RESTROOM	1	1	1	1
49	RESTROOM	1	1	1	1
50	RESTROOM	1	1	1	1

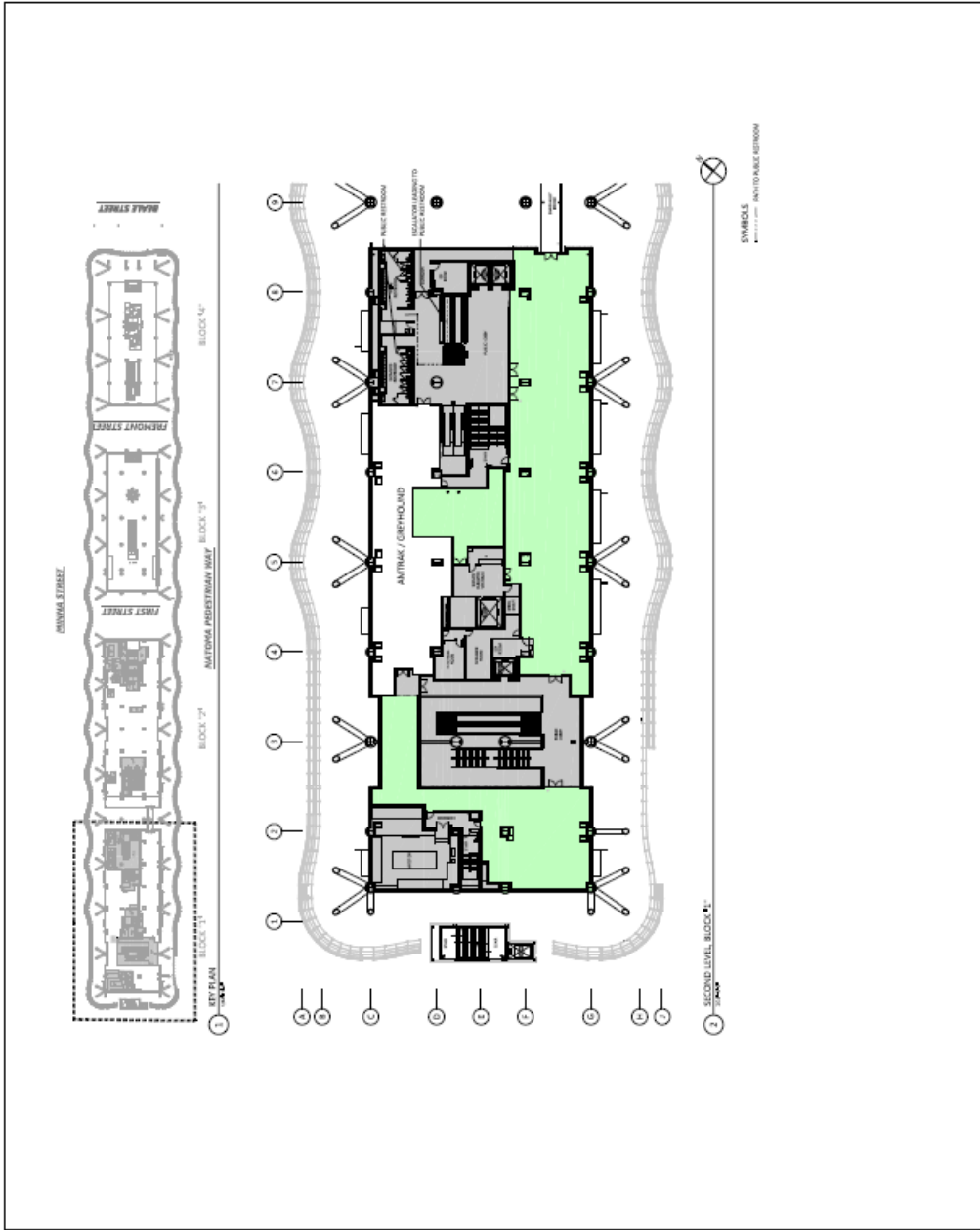
RESTROOM / PLUMBING OCCUPANT LOAD ANALYSIS

NO.	DESCRIPTION	UNIT	PLUMBING CALCULATION	PLUMBING CALCULATION	PLUMBING CALCULATION
1	RESTROOM	1	1	1	1
2	RESTROOM	1	1	1	1
3	RESTROOM	1	1	1	1
4	RESTROOM	1	1	1	1
5	RESTROOM	1	1	1	1
6	RESTROOM	1	1	1	1
7	RESTROOM	1	1	1	1
8	RESTROOM	1	1	1	1
9	RESTROOM	1	1	1	1
10	RESTROOM	1	1	1	1
11	RESTROOM	1	1	1	1
12	RESTROOM	1	1	1	1
13	RESTROOM	1	1	1	1
14	RESTROOM	1	1	1	1
15	RESTROOM	1	1	1	1
16	RESTROOM	1	1	1	1
17	RESTROOM	1	1	1	1
18	RESTROOM	1	1	1	1
19	RESTROOM	1	1	1	1
20	RESTROOM	1	1	1	1
21	RESTROOM	1	1	1	1
22	RESTROOM	1	1	1	1
23	RESTROOM	1	1	1	1
24	RESTROOM	1	1	1	1
25	RESTROOM	1	1	1	1
26	RESTROOM	1	1	1	1
27	RESTROOM	1	1	1	1
28	RESTROOM	1	1	1	1
29	RESTROOM	1	1	1	1
30	RESTROOM	1	1	1	1
31	RESTROOM	1	1	1	1
32	RESTROOM	1	1	1	1
33	RESTROOM	1	1	1	1
34	RESTROOM	1	1	1	1
35	RESTROOM	1	1	1	1
36	RESTROOM	1	1	1	1
37	RESTROOM	1	1	1	1
38	RESTROOM	1	1	1	1
39	RESTROOM	1	1	1	1
40	RESTROOM	1	1	1	1
41	RESTROOM	1	1	1	1
42	RESTROOM	1	1	1	1
43	RESTROOM	1	1	1	1
44	RESTROOM	1	1	1	1
45	RESTROOM	1	1	1	1
46	RESTROOM	1	1	1	1
47	RESTROOM	1	1	1	1
48	RESTROOM	1	1	1	1
49	RESTROOM	1	1	1	1
50	RESTROOM	1	1	1	1

RESTROOM / OCCUPANT LOAD ANALYSIS

NO.	DESCRIPTION	UNIT	PLUMBING CALCULATION	PLUMBING CALCULATION	PLUMBING CALCULATION
1	RESTROOM	1	1	1	1
2	RESTROOM	1	1	1	1
3	RESTROOM	1	1	1	1
4	RESTROOM	1	1	1	1
5	RESTROOM	1	1	1	1
6	RESTROOM	1	1	1	1
7	RESTROOM	1	1	1	1
8	RESTROOM	1	1	1	1
9	RESTROOM	1	1	1	1
10	RESTROOM	1	1	1	1
11	RESTROOM	1	1	1	1
12	RESTROOM	1	1	1	1
13	RESTROOM	1	1	1	1
14	RESTROOM	1	1	1	1
15	RESTROOM	1	1	1	1
16	RESTROOM	1	1	1	1
17	RESTROOM	1	1	1	1
18	RESTROOM	1	1	1	1
19	RESTROOM	1	1	1	1
20	RESTROOM	1	1	1	1
21	RESTROOM	1	1	1	1
22	RESTROOM	1	1	1	1
23	RESTROOM	1	1	1	1
24	RESTROOM	1	1	1	1
25	RESTROOM	1	1	1	1
26	RESTROOM	1	1	1	1
27	RESTROOM	1	1	1	1
28	RESTROOM	1	1	1	1
29	RESTROOM	1	1	1	1
30	RESTROOM	1	1	1	1
31	RESTROOM	1	1	1	1
32	RESTROOM	1	1	1	1
33	RESTROOM	1	1	1	1
34	RESTROOM	1	1	1	1
35	RESTROOM	1	1	1	1
36	RESTROOM	1	1	1	1
37	RESTROOM	1	1	1	1
38	RESTROOM	1	1	1	1
39	RESTROOM	1	1	1	1
40	RESTROOM	1	1	1	1
41	RESTROOM	1	1	1	1
42	RESTROOM	1	1	1	1
43	RESTROOM	1	1	1	1
44	RESTROOM	1	1	1	1
45	RESTROOM	1	1	1	1
46	RESTROOM	1	1	1	1
47	RESTROOM	1	1	1	1
48	RESTROOM	1	1	1	1
49	RESTROOM	1	1	1	1
50	RESTROOM	1	1	1	1





## EXHIBIT C

### INSURANCE REQUIREMENTS

1. Tenant shall procure, at Tenant's sole cost and expense, policies of insurance to be in force and maintained at all times during the Term (or if earlier, commencing as of the date Tenant is first provided with access to the Premises) in accordance with the terms set forth below:

- A. **Commercial Property Insurance**, including special form perils endorsement or equivalent insuring the "Tenant FF&E", the "Tenant Utility Facilities", and the "Tenant Equipment" (each as hereinafter defined) including plate glass, and other breakables in the Premises for the full replacement value, without deduction for depreciation. This insurance must include all Tenant's work, improvement and betterments, inventory, merchandise, signs, goods, trade fixtures, furnishings, equipment, furniture, wall coverings, floor coverings, and other personal property including personal property in the Tenant's care, custody and control. Tenant's insurance shall insure for loss from flood, including coverage for water damage from all causes including but not limited to sprinkler damage, sewer discharge or backup, water line breakage, and overflow from other tenant's space or any portion of the Center which is not part of the Premises. Where available, Tenants shall insure for earthquake. Landlord shall be named as loss payee with respect to the coverage for the Tenant's improvements and betterments. All policies shall have a Waiver of Subrogation endorsement in favor of all Additional Insureds.
- B. **Loss of Business Income Insurance**, including extra expense and contingent business income coverage. The insurance limits for this insurance shall be based upon a minimum of twelve (12) months of income with a three hundred sixty five (365) day "Extended Period of Indemnity" endorsement.
- C. **Workers' Compensation** including Employer's Liability Insurance with limits of not less than \$1,000,000 each accident, which limit may be met by a combination of primary and excess insurance meeting the statutory limits of the State of California. All policies shall have a Waiver of Subrogation endorsement in favor of all Additional Insureds.
- D. **Commercial General Liability** (I.S.O. 2001 Form or equivalent approved by Landlord) in Tenant's name with limits of liability in the amount of at least \$2,000,000 each occurrence/\$4,000,000 general aggregate limit (other than products-completed operations)/\$2,000,000 products/completed operations aggregate limit on a combined single limit basis for injuries to persons (including death) and damage to property. Such policy should be written on an occurrence form, and shall include:
  - i. Contractual coverage for liability assumed by Tenant under the Lease;
  - ii. Personal and advertising injury coverage;
  - iii. Products-completed operations;
  - iv. Independent contractors coverage;
  - v. Liquor liability coverage, when applicable;
  - vi. "XCU" coverage (explosion, collapse, and underground hazards) where necessary;
  - vii. Contractual liability exclusion, applicable to construction or demolition operations to be performed within 50 feet of railroad tracks, must be removed, where necessary; and
  - viii. Additional Insured endorsement (I.S.O. Form CG 20 26 07/04 and CG 20 37 07/04 or its equivalent approved by Landlord) naming the Additional Insureds.

- E. **Business Automobile Liability** - (I.S.O. Form CA 00 01 10 01 or equivalent approved by Landlord) in Tenant's name with limits of liability in the amount of at least \$1,000,000 each accident for claims for bodily injuries (including death) to persons and for damage to property arising out of the ownership, maintenance or use of any owned, hired or non-owned motor vehicle.
  - F. Landlord reserves the right to require additional policies of insurance and/or higher limits of liability based on particular tenant uses.
2. During the performance of any construction, installation or alteration work by Tenant, Tenant shall cause its contractors to carry the following insurance and such additional insurance having limits as Landlord may from time to time require which shall meet all general policy provisions as set forth in this Agreement:
- A. **Workers' Compensation** including employer's liability insurance with limits of not less than \$1,000,000, which limit may be met by a combination of primary and excess insurance meeting the statutory limits of the State of California. All policies shall have a Waiver of Subrogation endorsement in favor of all Additional Insureds.
  - B. **Commercial General Liability** (I.S.O. 2001 Form or equivalent approved by Landlord) in the contractor's name with limits of liability in the amount of at least \$5,000,000 each occurrence/\$10,000,000 general Aggregate Limit (other than products-completed operations)/\$10,000,000 products/completed operations aggregate limit on a combined single limit basis for injuries to persons (including death) and damage to property. Such policy should be written on an occurrence form, and shall include:
    - i. Contractual coverage for liability assumed by the contractor;
    - ii. Personal and advertising injury coverage;
    - iii. Products-completed operations
    - iv. Independent contractors coverage;
    - v. "XCU" coverage (explosion, collapse, and underground hazards) where necessary;
    - vi. Contractual liability exclusion, applicable to construction or demolition operations to be performed within 50 feet of railroad tracks, must be removed, where necessary; and
    - vii. Additional Insured endorsement (I.S.O. Form CG 20 26 07/04 and CG 20 37 07/04 or its equivalent approved by Landlord) naming the Additional Insureds.
  - C. **Business Automobile Liability** (I.S.O. Form CA 00 01 10 01 or equivalent approved by Landlord) in the contractor's name with limits of liability in the amount of at least \$1,000,000 each accident for claims for bodily injuries (including death) to persons and for damage to property arising out of the ownership, maintenance or use of any owned, hired or non-owned motor vehicle.
  - D. **Builder's Risk/Installation Floater** on an all- risk completed value form in an amount equal to the total contract price. The insurance shall cover any and all real and personal property owned, used or intended for use or hereafter created, installed or acquired, including while in the course of building, erection, installation and assembly. The policy shall also include coverage for machinery, supplies and equipment, and other personal property of any kind owned, rented or in the care, custody and control of the contractor, and its subcontractors to be incorporated in the building, erection, assembly and



installation of the project. Said policy shall remain in force until the construction is completed and accepted. Landlord shall be named as loss payee with respect to the coverage for the Tenant's improvements and betterments. The policy shall have a Waiver of Subrogation endorsement in favor of all Additional Insureds. The policy shall provide that:

- i. Any requirement for co-insurance must be removed;
- ii. Said Policy is to be written with contractor as First Named Insured and the Additional Insureds;
- iii. Losses are to be adjusted with the Additional Insureds;
- iv. Policy shall be endorsed to provide that "all premium considerations are the sole responsibility of the contractor;" and
- v. Evidence of coverage requires submission of a policy. However, a temporary binder may be accepted pending issuance of the policy.

E. **Professional Liability Insurance**, which shall be required if professional services are to be performed, covering actual or alleged negligent acts, errors or omissions committed in the performance of activities and/or arising out of work performed by such contractor, regardless of the type of damages, and shall include, but not be limited to, claims involving infringement of intellectual property, including but not limited to infringement of copyright, trademark, trade dress and, to the extent such contractor has access to any confidential or sensitive information of Landlord or Landlord's network, invasion of privacy violations, information theft, damage to or destruction of electronic information, release of private information, alteration of electronic information, extortion and network security. Such insurance shall provide coverage for breach response costs as well as regulatory fines and penalties and credit monitoring expenses with limits sufficient to respond to these obligations. The policy shall also extend to include personal injury, bodily injury and property damage. The policy shall have a limit of liability of not less than \$2,000,000 per claim and \$2,000,000 in the aggregate, unless otherwise specified in writing by Landlord. Defense costs must be in addition to the limit of liability. Should the insurance have claims filed against it that are reasonably expected to erode 70% of the aggregate limits for any policy period, Tenant's contractor shall arrange with the insurer to reinstate the aggregate limit, at such contractor's expense. In addition to the coverage requirements above, the policy shall include:

- i. A retroactive date to coincide with or precede the insureds' initial services;
- ii. Policy allows for reporting of circumstances or incidents that might give rise to future claims; and
- iii. Either active policy coverage or an extended reporting period of at least three (3) years after termination of the agreement pursuant to which the services of contractor are provided.

3. All policies of insurance required pursuant to Sections 1 and 2 above must be written in accordance with the following requirements:

A. Policies shall be endorsed to be primary insurance coverage at least as broad as ISO CG 10 01 04 13 as respects the Additional Insureds, shall be non-contributory to any other valid and collectible insurance, and must be exhausted before implicating any Landlord or Additional Insured policy available.

- B. Policies shall be written by companies with an A.M. Best Company rating of A, VII or better, that are licensed to do business in the State of California, and that are satisfactory to Landlord in form evidencing all coverages set forth above.
- C. Policies shall provide that coverage shall not be canceled, materially changed, or not renewed unless thirty (30) days' advance notice (ten (10) days' advance notice for non-payment of premiums) shall be delivered to Landlord at Landlord's Notice Address.
- D. Policies written on a "claims-made" basis are not acceptable except for Professional Liability.
- E. Policies shall require insurer to endeavor to provide evidence of renewal or replacement insurance with the same terms and conditions as required in the Lease at least two (2) weeks prior to the expiration date of the then-current policy.
- F. Policies shall contain deductibles of not more than \$25,000 unless approved by Landlord. Self-insured retentions must be declared to and approved by Landlord. The party responsible for procuring the applicable insurance shall be responsible for all claim expense and loss payments within the deductible or self-insured retention on the same basis as would be the case if commercial insurance was available for the loss. Landlord may require that the party procuring the applicable insurance provide proof of ability to pay losses and related investigations, claim administration and defense expenses with any self-insured retention.
- G. Landlord and the Additional Insureds are to be covered as additional insured on all insurance required by Sections 1 and 2 above, other than (i) Tenant's Personal Property Insurance to the extent of coverage for loss to Tenant FF&E owned only by Tenant and any Tenant Equipment owned only by Tenant, (ii) worker's compensations insurance, and (ii) Professional Liability Insurance.
- H. All references to the required forms shall comply with the Insurance Services Office, Inc. ("ISO") or its equivalent approved by the Insurance Department of the State of California.

4. Insurance Submission Requirements.

- A. Tenant shall furnish evidence of all policies prior to occupancy or start of any work to Landlord and Landlord's Notice Address.
- B. Certificates of insurance may be supplied as evidence of such aforementioned policies. However, if requested by Landlord, Tenant shall deliver to Landlord, within thirty (30) days of such request, a copy of such policies required to be carried hereunder, certified by the insurance carrier as being true and complete. If a certificate of insurance is submitted it must: (1) be signed by an authorized representative of the insurance carrier or producer and notarized; (2) disclose any deductible, sub-limit, self-insured retention, aggregate limit or any exclusions to the policy that materially change the coverage; (3) indicate the Additional Insureds and Named Insureds as required herein, and Tenant shall provide a copy of the Additional Insured endorsement (s) as required in the foregoing and must include the policy number(s); and (4) expressly reference the inclusion of all required endorsements.

5. **Definitions.** For purposes hereof:

- A. **"Center Equipment"** means all systems, equipment and fixtures incorporated in the Center used, useful, or necessary to operate the Center including all systems, equipment and fixtures incorporated in the Center, all utility systems serving the Center (other than those serving only a tenant's leased premises), public art installations, media/signage equipment and security and surveillance items, but excluding any and all Tenant Equipment.
- B. **"Center FF&E"** means all movable furniture, furnishings, fixtures, equipment, and personal property of Landlord or anyone claiming through Landlord (excluding Center Equipment), including any equipment necessary or desirable for the maintenance and repair of the Center which is owned by Landlord.
- C. **"Tenant Equipment"** means any and all fixtures or equipment incorporated in the Premises and installed by Tenant, at Tenant's expense, and used, useful, or necessary to operate the Premises, exclusive of Center Equipment and the Tenant FF&E, and which shall become the property of Landlord upon the expiration, or earlier termination of the Lease.
- D. **"Tenant FF&E"** means all movable furniture, furnishings, fixtures, equipment, and personal property owned by Tenant (excluding Center Equipment and Tenant Equipment) that may be removed without material damage to the Premises and without adversely affecting: (a) the structure of the Premises or the Center; (b) any electrical, plumbing, mechanical, or other system in the Premises or the Center; (c) the present or future operation of any such system; or (d) the present or future provision of any utility service to the Premises or the Center. Tenant FF&E owned by Tenant includes, without limitation, items such as merchandise, signs, goods, trade fixtures, factory equipment, furniture, movable equipment, telephone, telecommunications and facsimile transmission equipment, point of sale equipment, televisions, radios, network racks, computer systems and peripherals, and equipment purchased, at Tenant's cost, but shall not include any such items paid for by Landlord.
- E. **"Tenant Utility Facilities"** means all utility and mechanical facilities and systems exclusively serving the Premises.

6. **Additional Insured.**

- A. The initial list of Additional Insureds consist of the following:
  - i. Transbay Joint Powers Authority;
  - ii. City and County of San Francisco;
  - iii. Alameda-Contra Costa Transit District;
  - iv. Peninsula Corridor Joint Powers Board – Caltrain;
  - v. State of California, Department of Transportation;
  - vi. Trustee, the Series 1 Holders, the LC Banks and the Direct Placement Banks, and their officers, agents and employees, as those terms are defined in the "Sublease – TJPA Property, dated as of January 1, 2017, by and between U.S. Bank National Association, in its capacity as Trustee, as Sublessor, and City and County of San Francisco, as Sublessee" recorded in the official records of the City and County of San Francisco on January 17, 2017 as document number 2017-K395369;

- vii. United States Department of Transportation, an agency of the United States of America, acting by and through the Executive Director of the Build America Bureau;
- viii. LPC West Transit Management LLC;
- ix. California High Speed Rail Authority; and
- x. All of the officers, agents, and employees of each of the above.

B. The initial Additional Insureds listed above shall also include such other parties as Landlord may request from time to time.

DRAFT

EXHIBIT D

RULES AND REGULATIONS

**SALESFORCE TRANSIT CENTER**

TENANT RULES AND REGULATIONS

(version October 12, 2017)

1. These Tenant Rules and Regulations (“Tenant Rules”) shall apply to Tenant and all of its employees, agents, visitors, guests, customers, licensees, contractors, or invitees (collectively, “Tenant Invitees”); all references to “Tenant” are intended to also apply to any Tenant Invitees. Tenant is responsible for ensuring that its Tenant Invitees are informed of and comply with these Tenant Rules.

2. The sidewalks, halls, passages, exits, entrances, elevators and stairways of the transit center shall not be obstructed or used for any purpose other than for ingress or egress in the manner for which they were designed.

3. No sign, placard, picture, advertisement, name, or notice (except legally required notices), or other items shall be placed, inscribed, displayed, printed, or affixed on or near any window, door, partition or wall which may appear unsightly from outside the premises leased to Tenant (“Premises”). No curtains, draperies, blinds, shutters, shades, screens, sunscreens or other coverings, hangings or decorations shall be attached to, hung or placed in or used in connection with any window of the transit center or Premises. No awning, canopy or other projection of any kind over or around the windows or entrances of the Premises shall be installed.

4. The Premises shall not be used for lodging or sleeping, for washing clothes or for any improper, objectionable, or illegal purposes, and, unless ancillary to a restaurant or other food service use specifically authorized in the Lease, no cooking shall be done or permitted in the Premises, except that the preparation of coffee, tea, hot chocolate and similar items for Tenant and its employees shall be permitted, provided that Tenant uses Underwriter’s Laboratory-approved equipment in accordance with all applicable laws and codes and otherwise complies with these Tenant Rules.

5. The toilet rooms, toilets, urinals, wash bowls and other plumbing facilities and apparatus shall not be used for any purpose other than that for which they were constructed, no grease or other foreign substance of any kind whatsoever shall be deposited therein, and the expense of any breakage, stoppage or damage (whether on or off the Premises) resulting from violation of this rule by Tenant shall be paid for by Tenant.

6. No additional locks or bolts of any kind shall be placed upon any of the doors or windows, nor shall any changes be made in existing locks or the mechanisms thereof. Tenant shall not duplicate any keys or access cards provided to it. Each Tenant must, upon the termination of its tenancy, give to the Landlord all keys and access cards to doors in the transit center and the Premises, either furnished to, or otherwise procured by, such Tenant, and in the event of the loss of any keys or access cards so furnished, such Tenant shall pay the Landlord the cost of replacing the same or changing the lock or locks opened by such lost key if Landlord shall deem it necessary to make such change. Tenant shall bear all liability for claims or injuries resulting from misuse of keys or access cards.

7. All doors and windows of the Premises shall be closed and securely locked during all times when the business is not open to the public, and Tenant shall bear all liability for claims or injuries resulting from such failure or carelessness.

8. All water faucets, water apparatus, equipment, and appliances that are not designed to be left unattended shall be shut off when not in use, and Tenant shall bear all liability for claims or injuries resulting from such failure or carelessness.

9. No kerosene, gasoline or flammable, combustible, or explosive fluids or materials shall be used, kept, or stored in the Premises, other than a commercially reasonable supply of chemicals that are typically used for office machines and for cleaning. Tenant shall install and maintain within the Premises, at Tenant's cost and expense, visibly marked, properly operational fire extinguishers next to all duplicating or photocopy machines, and any other heat producing equipment, and as required by code or the Fire Department.

10. No penetration of the roof of the transit center is permitted. No boring or cutting for telephone, telegraph or electric wires, or for any pipes, plumbing, ventilation or for any other similar intrusions will be allowed without the consent of Landlord, and any such intrusions that are permitted shall be introduced at the place and in the manner approved by Landlord. The location of telephones, call boxes and all other equipment affixed to the Premises shall be subject to the approval of Landlord, which shall not be unreasonably withheld.

11. No sale of newspapers, magazines, periodicals, theater tickets or any other goods, merchandise or service is permitted from the hallways, foyers, sidewalks, or other common spaces of the transit center adjacent to the Premises. No display or sale of merchandise, or placement or storage of carts, portable signs, devices or any other objects is permitted outside the defined exterior walls, roof and permanent doorways of the Premises.

12. The Premises shall not be used for manufacturing of any kind, including manufacture or sale of narcotics or tobacco in any form, or for any business or activity other than that specifically provided for in the Lease.

13. No use or operation of any vending or coin operated machines, video or mechanical games, or automated teller machines shall be permitted on the Premises.

14. Landlord shall have the right to prohibit any advertising by any Tenant which, in Landlord's opinion, tends to impair the reputation of the transit center or its desirability as a transit center and retail complex. Upon written notice from Landlord, any such Tenant shall refrain from or discontinue such advertising.

15. No radio or television antenna, loudspeaker or other device may be installed on the roof or exterior walls of the Premises or the transit center. No advertising method shall be utilized in the Premises which can be heard or perceived outside the Premises, including without limitation flashing lights, searchlights, loudspeakers, phonographs, radios or television equipment.

16. No canvassing, soliciting, peddling or distribution of handbills or any other written material outside the Premises is permitted.

17. In any interior space in the transit center, Tenant shall not use any hand trucks or other transport equipment, except those equipped with air-filled or soft rubber tires and side guards. All hand trucks or other transport equipment shall be permanently marked with Tenant name. No other vehicles of any kind shall be brought into the transit center or kept in or about the Premises.

18. All loading, unloading and delivery of merchandise, supplies, materials, garbage and refuse shall be made only through such entryways and elevators and at such times as Landlord shall designate. While loading and unloading, Tenant shall not obstruct or permit the obstruction of the

entryways to the transit center or any tenant's space therein. Tenant expressly assumes (i) all risk of damage to any and all articles so loaded, unloaded or delivered, and (ii) all risk of injury incidental to any such loading, unloading or delivery, whether or not such injured person is engaged in such activity, and Tenant shall repair at its cost and expense any damage to the transit center resulting from such activities.

19. Landlord shall have the right to prescribe the weight, size and position of all equipment, materials, supplies, furniture or other property brought into the transit center. All deliveries, removals, or the carrying in or out of any stock, equipment, freight, furniture, safes, or bulky matter of any description must take place in the manner and during the hours which the Landlord may determine from time to time. The moving of safes, furniture, or other fixtures or bulky matter of any kind must be made upon previous notice to the Landlord and under Landlord's supervision, and the person employed by Tenant for such work must be acceptable to the Landlord. Tenant expressly assumes (i) all risk of damage to any and all articles moved, and (ii) all risk of injury incidental to any such moving, whether or not such injured person is engaged in such activity, and Tenant shall repair at its cost and expense any damage to the transit center resulting from such activities.

20. Tenant shall store, remove, and dispose of its waste and recyclables following Landlord's current waste and recycling procedures, which are subject to change from time to time. Among other things, Tenant shall store all waste and recyclables within the Premises until removal. Tenant shall only place waste and recyclables outside the Premises in locations and containers approved by Landlord. No material shall be placed in waste containers if the material is of such nature that it may not be disposed of in the ordinary and customary manner of removing and disposing of waste and recyclable, or in violation of any law or ordinance governing disposal. If Tenant generates waste or recyclables that require special hauling (e.g., furniture, fixtures, and equipment), Tenant must coordinate such disposal in advance with the designated hauling provided; such materials may not be left in the common area loading dock. All waste and recyclables shall be disposed only through entry ways and elevators provided for such purpose and at such times as Landlord shall designate.

21. Tenant shall not permit waste of the Premises; Tenant shall regularly conduct cleaning and janitorial activities, especially in bathrooms, kitchens and janitorial spaces to remove mildew and prevent moist conditions.

22. No animals shall be permitted in the Premises, except for guide or signal dogs in use by a person with a disability.

23. Tenant shall not (i) use, keep or permit to be used or kept any foul or noxious gas or substance in the Premises, (ii) permit or suffer the Premises to be occupied or used in any manner offensive or objectionable to Landlord and other tenants of the transit center by reason of noise, odors, fumes, smoke, vapors or unusual lights, including without limitation spotlights and/or vibrations, or (iii) interfere in any way with other tenants of the transit center.

24. All electrical ceiling fixtures hung in the Premises must be of a quality, type, design, and bulb color approved by Landlord.

25. Tenant shall immediately, upon request from Landlord (which request need not be in writing), reduce its lighting in the Premises for temporary periods designated by Landlord, when required in Landlord's judgment to prevent overloads of the mechanical or electrical systems of the transit center.

26. Tenant shall cooperate with Landlord's efforts to implement the Building's Sustainability Practices and the applicable Green Building Standards, if any, including, but not limited to, complying with Landlord's then-current energy saving efforts and participating in any recycling programs and occupant satisfaction and transportation surveys.

27. No heating or air conditioning unit or other similar apparatus shall be installed or used in the Premises.

28. Landlord reserves the right to select the name of the transit center and to make such change or changes of name as it may deem appropriate from time to time, and to adopt naming rights guidelines regarding the use of the transit center name that must be followed by Tenant.

29. No smoking (including use of e cigarettes and smokeless cigarettes) is permitted in the transit center, including the Premises, or within 25 feet of any entrance to the transit center, public walkways or the transit center's outdoor air intakes.

30. Tenant shall be solely responsible for providing and paying for all security personnel, devices, and systems that Tenant deems necessary for the protection of the Premises. Tenant supplied security shall coordinate with the TJPA Chief Security Officer.

31. Tenants are required to participate in the transit center's Trusted Access Program, badging, and other security, safety, and emergency preparedness programs. Landlord reserves the right to modify such programs over time.

32. Landlord intends to uniformly apply and enforce these Tenant Rules among all similarly situated Tenants. Landlord may, however, waive any one (1) or more of the rules and regulations for the benefit of any particular Tenant where Landlord deems reasonable in a particular circumstance; no such waiver by Landlord shall be construed as a waiver of the rules and regulations in favor of any other Tenant, nor prevent Landlord from thereafter enforcing any rule or regulation against any or all of the Tenants of the transit center.

33. These Tenant Rules and are intended to supplement the terms and conditions of a Tenant's lease. In the event of any conflict between the Tenant's lease and these Tenant Rules, the lease controls.

34. Landlord reserves the right to modify or rescind any of these Tenant Rules and to make future rules and regulations as in its reasonable judgment may from time to time be reasonably necessary or desirable for the safety, care or cleanliness of the transit center, or for the preservation of good order therein. Such new or modified rules and regulations, when made and written notice thereof is given to Tenant, shall be binding on Tenant.



## EXHIBIT E

### NAMING RIGHTS REQUIREMENTS

1. These Naming Rights Rules and Regulations (“Naming Rights Rules”) shall apply to Tenant and all of its employees, agents, visitors, guests, customers, licensees, contractors, or invitees (collectively, “Tenant Invitees”); all references to “Tenant” are intended to also apply to any Tenant Invitees. Tenant is responsible for ensuring that its Tenant Invitees are informed of and comply with these Naming Rights Rules.
2. Tenant acknowledges that TJPA is party to a “Naming Rights Agreement” with the “Naming Rights Sponsor” for the Project, and these Naming Rights Rules are intended to insure TJPA’s and Landlord’s compliance with such Naming Rights Agreement. Tenant’s failure to comply with the Naming Rights Rules may cause TJPA and Landlord to be in breach of the Naming Rights Agreement, and Tenant shall indemnify and hold TJPA and Landlord harmless from all losses, claims, suits, actions, damages, and liability arising from Tenant’s breach of these Naming Rights Rules.
3. Tenant shall not use any of the names, logos, or marks of the Project or the Naming Rights Sponsor (or any derivatives thereof), without Landlord’s prior written approval, which approval may be given or withheld in Landlord’s sole discretion. If use of the names, logos or marks of the Project or the Naming Rights Sponsor is so permitted by Landlord, such use shall be of high quality, commensurate with the quality that consumers have come to expect from the Naming Rights Sponsor, and shall otherwise comply with the requirements of Landlord and the Naming Rights Sponsor. If Tenant fails to comply with the terms of these Naming Right Rules, Landlord may require Tenant, at Tenant’s cost, to immediately cease use of the names, logos or marks of the Project or the Naming Rights Sponsor or otherwise resolve any concerns. Notwithstanding any prior approval by Landlord, Landlord may require Tenant, at Tenant’s cost, to cease use of the names, logos or marks of the Project or the Naming Rights Sponsor in a manner which can be reasonably interpreted as being profane, insulting or defamatory towards the Naming Rights Sponsor.
4. Tenant shall use commercially reasonable efforts to refer to the Project only using the approved venue name, logo or mark for the Project (to be provided to Tenant upon request) in all public communications.
5. Tenant shall not place, install, construct or maintain any signage, advertising, names, insignias, trademarks, descriptive materials or similar items (each, a “Sign”) in or about the Project without Landlord’s prior written approval, which approval may be given or withheld in Landlord’s sole discretion. If Landlord approves any such signage, Landlord may require the use of venue’s or the Naming Rights Sponsor’s names, logos or marks on the frames or housings of any such signage, at the Naming Rights Sponsor’s cost, if required pursuant to the Naming Rights Agreement.
6. Notwithstanding any prior approval by Landlord, Landlord may require Tenant to remove, at Tenant’s cost, any content on any Sign which can be reasonably interpreted as being profane, insulting or defamatory towards the Naming Rights Sponsor.
7. Landlord reserves the right to modify or rescind any of these Naming Rules and to make future rules and regulations as in its reasonable judgment may from time to time be reasonably necessary or desirable to ensure compliance with the Naming Rights Agreement (as may be amended) or otherwise for the safety, care or cleanliness of the transit center, or for the preservation of good order therein. Such new or modified rules and regulations, when made and after ten (10) business days written notice thereof is given to Tenant, shall be binding on Tenant.

## EXHIBIT F

### GOVERNMENT REQUIREMENTS

**1. MacBride Principles - Northern Ireland.** Pursuant to San Francisco Administrative Code Section 12.F.5, the City and County of San Francisco urges companies doing business in Northern Ireland to move towards resolving employment inequities, and encourages such companies to abide by the MacBride Principles. The City and County of San Francisco urges San Francisco companies to do business with corporations that abide by the MacBride Principles. The person executing this Lease on behalf of Tenant acknowledges that he or she has read and understood this Section.

**2. Tropical Hardwood and Virgin Redwood Ban.** Pursuant to Section 804(b) of the San Francisco Environment Code, Landlord urges Tenant not to import, purchase, obtain, or use for any purpose, any tropical hardwood, tropical hardwood wood product, virgin redwood or virgin redwood wood product. Except as expressly permitted by the application of Section 802(b) and 803(b) of the San Francisco Environment Code, Tenant shall not provide any items for the construction of tenant improvements or alterations in the Premises, or otherwise in the performance of this Lease, which are tropical hardwoods, tropical hardwood wood products, virgin redwood, or virgin redwood wood products.

**3. Preservation-Treated Wood Containing Arsenic.** Tenant may not purchase preservative-treated wood products containing arsenic in the performance of this Lease unless an exemption from the requirements of San Francisco Environment Code Chapter 13 is obtained from the Department of Environment under Section 1304 of the Environment Code. The term “**preservative-treated wood containing arsenic**” shall mean wood treated with a preservative that contains arsenic, elemental arsenic, or an arsenic copper combinations, including chromated copper arsenate preservative, ammoniac copper zinc arsenate preservative, or ammoniacal copper arsenate preservative. Tenant may purchase preservative-treated wood products on the list of environmentally preferable alternatives prepared and adopted by the Department of Environment.

**4. Federal Nondiscrimination, Affirmative Action, and Other Requirements.**

(a) Tenant shall comply with 49 C.F.R. Section 26.7 (as may subsequently be amended), portions of which are summarized as: Tenant must never exclude any person from participation in, deny any person the benefits of, or otherwise discriminate against anyone in connection with the rights and permissions granted under the Lease on the basis of race, color, sex, or national origin.

(b) Tenant shall comply with 49 C.F.R. Section 27.7 (as may be subsequently amended), portions of which are summarized as: (a) General. No qualified handicapped person shall, solely by reason of his disability, be excluded from participation in, be denied the benefits of, or otherwise be subjected to discrimination in connection with the rights and permissions granted under the Lease. (b) Discriminatory actions prohibited. (1) Tenant, in providing any aid, benefit, or service, may not, directly or through contractual, licensing, or other arrangements, on the basis of disability: (i) Deny a qualified handicapped person the opportunity to participate in or benefit from the aid, benefit, or service; (ii) Afford a qualified handicapped person an opportunity to participate in or benefit from the aid, benefit, or service that is not substantially equal to that afforded persons who are not handicapped; (iii) Provide a qualified handicapped person with an aid, benefit, or service that is not as effective in affording equal opportunity to obtain the same result, to gain the same benefit, or to reach the same level of achievement as persons who are not handicapped; (iv) Provide different or separate aid, benefits, or services to handicapped persons or to any class of handicapped persons unless such action is necessary to provide qualified handicapped persons with aid, benefits or services that are as effective as those provided to persons who are not handicapped; (v) Aid or perpetuate discrimination against a qualified handicapped

person by providing financial or other assistance to an agency, organization, or person that discriminates on the basis of disability in providing any aid, benefit, or service to beneficiaries of the recipient's program or activity; (vi) Deny a qualified handicapped person the opportunity to participate in conferences, in planning or advising recipients, applicants or would-be applicants, or (vii) Otherwise limit a qualified handicapped person in the enjoyment of any right, privilege, advantage, or opportunity enjoyed by others receiving an aid, benefit, or service. As required by 49 C.F.R. 27.9(b), Tenant agrees to comply with the requirements of 49 C.F.R. Part 27.

(c) Tenant shall comply with 49 C.F.R. Part 37 (as may be subsequently amended), portions of which are summarized as: In constructing and altering transit facilities, Tenant shall comply with the regulations of the Department of Justice implementing Title III of the ADA (28 CFR part 36).

(d) Tenant shall comply with U.S. Department of Transportation Federal Transit Administration Master Agreement FY 2017 (as annually updated), particularly relating to conflicts of interest, debarment and suspension.

## **5. City and County of San Francisco Equal Employment Opportunity / Nondiscrimination Ordinance.**

(a) Tenant Shall Not Discriminate. In the performance of this Lease, Tenant agrees not to discriminate against any employee, Landlord employee working with Tenant, applicant for employment with Tenant, or against any person seeking accommodations, advantages, facilities, privileges, services, or membership in all business, social, or other establishments or organizations operated by Tenant, on the basis of the fact or perception of a person's race, color, creed, religion, national origin, ancestry, age, height, weight, sex, sexual orientation, gender identity, domestic partner status, marital status, disability or Acquired Immune Deficiency Syndrome or HIV status (AIDS/HIV status), or association with members of such protected classes, or in retaliation for opposition to discrimination against such classes.

Such action shall include, but shall not be limited to, the following: employment, upgrading, demotion or transfer; recruitment or recruitment advertising; lay-offs or termination; rates of pay or other forms of compensation; and selection for training, including apprenticeship. Tenant further agrees to post in conspicuous places, available to employees and applicants for employment, notices setting forth the provisions of this nondiscrimination clause. Tenant is encouraged to actively recruit minorities and women for its workforce and take other steps, such as on-the-job training and education, to ensure nondiscrimination in the Tenant's employment practices.

(b) Subcontracts. Tenant shall include in all subleases and other subcontracts relating to the Premises hereunder a nondiscrimination clause in substantially the form of subsection (a) above. In addition, Tenant shall incorporate by reference in all subleases and other subcontracts the provisions of Sections 12B.2(a), 12B.2(c)-(k), and 12C.3 of the San Francisco Administrative Code and shall require all subtenants and other subcontractors to comply with such provisions. Tenant's failure to comply with the obligations in this subsection shall constitute a material breach of this Lease.

(c) Nondiscrimination in Benefits. Tenant does not as of the date of this Lease and will not during the Term, in any of its operations in San Francisco, where the work is being performed for the Landlord, or elsewhere within the United States, discriminate in the provision of bereavement leave, family medical leave, health benefits, membership or membership discounts, moving expenses, pension and retirement benefits or travel benefits, as well as any benefits other than the benefits specified above, between employees with domestic partners and employees with spouses, and/or between the domestic partners and spouses of such employees, where the domestic partnership has been registered with a

governmental entity pursuant to state or local law authorizing such registration, subject to the conditions set forth in Section 12B.2(b) of the San Francisco Administrative Code.

(d) **Condition to Contract.** As a condition to this Agreement, Tenant shall execute the appropriate “San Francisco Administrative Code Chapters 12B & 12C Declaration: Nondiscrimination in Contracts and Benefits” form (Form CMD-12B-101) with supporting documentation and file the form with Landlord.

(e) **Incorporation of Administrative Code Provisions by Reference.** The provisions of Chapters 12B and 12C of the San Francisco Administrative Code relating to nondiscrimination by parties contracting for the lease of property are incorporated in this Section by reference and made a part of this Lease as though fully set forth herein. The parties agree that the San Francisco law applies to this Lease as if Landlord were the City and County of San Francisco for purposes of application of the law to this Lease. Tenant shall comply fully with and be bound by all of the provisions that apply to this Lease under such Chapters of the Administrative Code, including but not limited to the remedies provided in such Chapters. Without limiting the foregoing, Tenant understands that pursuant to Section 12B.2(h) of the San Francisco Administrative Code, a penalty of \$50 for each person for each calendar day during which such person was discriminated against in violation of the provisions of this Lease may be assessed against Tenant and/or deducted from any payments due Tenant.

**6. Conflict of Interest.** Through its execution of this Lease, Tenant acknowledges that it is familiar with the provisions of Section 15.103 of City and County of San Francisco Charter, Article III, Chapter 2 of San Francisco’s Campaign and Governmental Conduct Code, and Sections 87100 et seq. and Sections 1090 et seq. of the Government Code of the State of California, and certifies that it does not know of any facts which constitute a violation of said provision and agrees that if it becomes aware of any such fact during the Term it shall immediately notify Landlord. The parties agree that the San Francisco law applies to this Lease as if Landlord were the City and County of San Francisco for purposes of application of the law to this Lease

**7. Prevailing Rates of Wage.** Tenant agrees that any person performing labor in the construction of any tenant improvements or alterations to the Premises, which Tenant provides under this Lease, shall pay be paid not less than the highest prevailing rates of salaries, wages, and employee benefits, to its employees working at the Center pursuant to this Lease consistent with federal and local requirements, and shall be subject to the same hours and working conditions, and shall receive the same benefits as in each case are provided for similar work in San Francisco, California. Tenant shall include, in any contract for construction of such tenant improvements and alterations, a requirement that all persons performing labor under such contract shall be paid not less than the highest prevailing rate of wages for the labor so performed. Tenant shall require any contractor to provide, and shall deliver to Landlord upon request, certified payroll reports with respect to all persons performing labor in the construction of such tenant improvement work or any alterations to the Premises.

**8. No Relocation Assistance; Waiver of Claims.** Tenant acknowledges that it will not be a displaced person at the time this Lease is terminated or expires by its own terms, and Tenant fully releases, waives, and discharges forever any and all claims or other Losses, against and covenants not to sue Landlord or any Landlord Entity under any Laws, including any and all claims for relocation benefits or assistance from Landlord under federal and state relocation assistance laws. Without limiting the terms of the Lease regarding Assignment and Subletting, Tenant shall cause any Transferee to expressly waive entitlement to any and all relocation assistance and benefits in connection with this Lease. Tenant shall indemnify, defend, and hold harmless Landlord and each Landlord Entity for any and all Losses arising out of any relocation assistance or benefits payable to any Transferee.

**9. Drug-Free Workplace.** Tenant acknowledges that pursuant to the Federal Drug-Free Workplace Act of 1989, the unlawful manufacture, distribution, possession or use of a controlled substance is prohibited on Landlord premises. Any violation of this prohibition by Tenant or any Tenant Entity shall constitute a default hereunder.

**10. Compliance with Americans With Disabilities Act.** Tenant acknowledges that, pursuant to the ADA, programs, services and other activities provided by a public entity, whether directly or through a contractor, must be accessible to the disabled public. Tenant shall provide the services specified in this Lease in a manner that complies with the ADA and any and all other applicable federal, state and local disability rights legislation. Tenant agrees not to discriminate against disabled persons in the provision of services, benefits or activities provided under this Lease, and further agrees that any violation of this prohibition on the part of Tenant, its employees, agents or assigns shall constitute a material breach of this Lease.

**11. Disability Access Obligations Notice.** In accordance with Chapter 38 of the San Francisco Administrative Code, the Disability Access Obligations Notice attached hereto as Schedule 1 (the "**Access Notice**") is incorporated herein by this reference. Execution of the Lease by the parties hereto shall be deemed to constitute and represent the parties' acknowledgement and execution of the Access Notice, notwithstanding that such Access Notice may not be separately executed. The terms of the Lease set forth the parties' respective obligations regarding the performance of and payment for disability access improvements. Further, each party shall use reasonable efforts to notify the other of alterations the notifying party may make to or which may affect the Premises or the Center that might impact accessibility under federal and state disability access laws. Such notification regarding alterations shall in no event be construed to limit Tenant's obligations or to expand Tenant's rights under this Lease, and, without limiting the generality of the foregoing, in no event shall such notification be deemed to constitute any notice required to be given by Tenant to Landlord under any other provision of this Lease. The Center may not currently meet all applicable construction-related accessibility standards, including standards for public restrooms and ground floor entrances and exits.

**12. Public Records.** Tenant acknowledges that Landlord is a public agency and the requirements of the California Public Records Act, California Government Code Section 6250 et seq., are applicable to Landlord's records.

**13. Pesticide Prohibition.** Tenant shall comply with the provisions of Section 308 of Chapter 3 of the San Francisco Environment Code (the "**Pesticide Ordinance**") which (i) prohibit the use of certain pesticides on certain property, (ii) require the posting of certain notices and the maintenance of certain records regarding pesticide usage, and (iii) require Tenant to submit to the Center an integrated pest management ("**IPM**") plan that (a) lists, to the extent reasonably possible, the types and estimated quantities of pesticides that Tenant may need to apply to the Premises during the terms of this Lease, (b) describes the steps Tenant will take to meet the City and County of San Francisco's IPM Policy described in Section 300 of the Pesticide Ordinance, and (c) identifies, by name, title, address and telephone number, an individual to act as Tenant's primary IPM contact person with the Landlord. In addition, Tenant shall comply with the requirements of Sections 303(a) and 303(b) of the Pesticide Ordinance. The parties agree that the San Francisco law applies to this Lease as if Landlord were the City and County of San Francisco for purposes of application of the law to this Lease

**14. Card Check Policy.** The provisions contained in the "Labor Representation Policy," attached hereto at Schedule 2 (the "**Card Check Policy**"), are incorporated into the Lease, and Tenant agrees to abide by such provisions. Such provisions supplement the provisions in this Agreement, and shall be interpreted in the broadest possible manner to avoid any conflicts. If there is an unavoidable conflict between the terms and provisions contained in the Card Check Policy and any other terms and

provisions of this Lease, in Landlord's sole determination, the terms and provisions contained in the Card Check Policy shall take precedence.

**15. Requiring Minimum Compensation.**

(a) Tenant agrees to comply fully with and be bound by all of the provisions of the Minimum Compensation Ordinance (MCO), as set forth in San Francisco Administrative Code Chapter 12P ("Chapter 12P"), including the remedies provided, and implementing guidelines and rules. The provisions of Chapter 12P are incorporated herein by reference and made a part of this Lease as though fully set forth. The text of the MCO is available on the web at [www.sfgov.org/olse/mco](http://www.sfgov.org/olse/mco). A partial listing of some of Tenant's obligations under the MCO is set forth in this Section. Tenant is required to comply with all the provisions of the MCO, irrespective of the listing of obligations in this Section.

(b) The MCO requires Tenant to pay Tenant's employees a minimum hourly gross compensation wage rate and to provide minimum compensated and uncompensated time off. The minimum wage rate may change from year to year and Tenant is obligated to keep informed of the then-current requirements. Any subcontract entered into by Tenant shall require the subcontractor to comply with the requirements of the MCO and shall contain contractual obligations substantially the same as those set forth in this Section. It is Tenant's obligation to ensure that any subcontractors of any tier under this Lease comply with the requirements of the MCO. If any subcontractor under this Lease fails to comply, Landlord may pursue any of the remedies set forth in this Section against Tenant.

(c) Tenant shall not take adverse action or otherwise discriminate against an employee or other person for the exercise or attempted exercise of rights under the MCO. Such actions, if taken within ninety (90) days after the exercise or attempted exercise of such rights, will be rebuttably presumed to be retaliation prohibited by the MCO.

(d) Tenant shall maintain employee and payroll records as required by the MCO. If Tenant fails to do so, it shall be presumed that the Tenant paid no more than the minimum wage required under State law.

(e) The Landlord is authorized to inspect Tenant's premises and conduct interviews with employees and conduct audits of Tenants.

(f) Tenant's commitment to provide the minimum compensation is a material element of the Landlord's consideration for this Lease. The Landlord in its sole discretion shall determine whether such a breach has occurred. The Landlord and the public will incur and suffer substantial damages, the exact amount of which are impractical or extremely difficult to determine if the Tenant fails to comply with these requirements. Tenant agrees that the sums set forth in Section 12P.6.1 of the MCO represent a reasonable approximation of the damages likely to be suffered by Landlord. Tenant agrees that the sums as liquidated damages are not a penalty, but are reasonable estimates of the loss that the Landlord and the public will incur for Tenant's noncompliance. The procedures governing the assessment of liquidated damages shall be those set forth in Section 12P.6.2 of Chapter 12P.

(g) Tenant understands and agrees that if it fails to comply with the requirements of the MCO, the Landlord shall have the right to pursue any rights or remedies available under Chapter 12P (including liquidated damages), under the terms of the contract, and under applicable law. If, within thirty (30) days after receiving Landlord's written notice of a breach of this Lease for violating the MCO, Tenant fails to cure such breach or, if such breach cannot reasonably be cured within such period, Tenant fails to commence efforts to cure within such period, or thereafter fails diligently to pursue such cure to completion, Landlord shall have the right to pursue any rights or remedies available under applicable law,

including those set forth in Section 12P.6(c) of Chapter 12P. Each of these remedies shall be exercisable individually or in combination with any other rights or remedies available to the Landlord.

(h) Tenant represents and warrants that it is not an entity that was set up, or is being used, for the purpose of evading the intent of the MCO.

(i) If Tenant is exempt from the MCO when this Lease is executed because the cumulative amount of agreements with Landlord for the fiscal year is less than Twenty Five Thousand Dollars (\$25,000), but Tenant later enters an agreement or agreements that cause Tenant to exceed that amount in a fiscal year, Tenant shall thereafter be required to comply with the MCO under this Lease. This obligation arises on the effective date of the agreement that causes the cumulative amount of agreements between the Tenant and Landlord to exceed Twenty Five Thousand Dollars (\$25,000) in the fiscal year.

**16. Requiring Health Benefits for Covered Employees.** Tenant agrees to comply fully with and be bound by all of the provisions of the Health Care Accountability Ordinance (HCAO), as set forth in San Francisco Administrative Code Chapter 12Q (“Chapter 12Q”), including the remedies provided, and implementing regulations, as the same may be amended from time to time. The provisions of Chapter 12Q are incorporated by reference and made a part of this Lease as though fully set forth herein. The text of the HCAO is available on the web at [www.sfgov.org/olse](http://www.sfgov.org/olse). A partial listing of some of Tenant's obligations under the HCAO is set forth in this Section. Tenant is required to comply with all the provisions of the HCAO, irrespective of the listing of obligations in this Section.

(a) For each Covered Employee, Tenant shall provide the appropriate health benefit set forth in Section 12Q.3 of the HCAO. If Tenant chooses to offer the health plan option, such health plan shall meet the minimum standards set forth by the San Francisco Health Commission.

(b) Notwithstanding the above, if the Tenant is a small business as defined in Section 12Q.3(e) of the HCAO, it shall have no obligation to comply with part (a) above.

(c) Tenant's failure to comply with the HCAO shall constitute a material breach of this Lease. Landlord shall notify Tenant if such a breach has occurred. If, within thirty (30) days after receiving Landlord's written notice of a breach of this Lease for violating the HCAO, Tenant fails to cure such breach or, if such breach cannot reasonably be cured within such period, Tenant fails to commence efforts to cure within such period, or thereafter fails diligently to pursue such cure to completion, Landlord shall have the right to pursue any rights or remedies available under applicable law, including those set forth in Section 12Q.5.1 and 12Q.5(f)(1-6). Each of these remedies shall be exercisable individually or in combination with any other rights or remedies available to Landlord.

(d) Any Subcontract entered into by Tenant shall require the Subcontractor to comply with the requirements of the HCAO and shall contain contractual obligations substantially the same as those set forth in this Section. Tenant shall notify Landlord when it enters into such a Subcontract and shall certify to Landlord that it has notified the Subcontractor of the obligations under the HCAO and has imposed the requirements of the HCAO on Subcontractor through the Subcontract. Each Tenant shall be responsible for its Subcontractors' compliance. If a Subcontractor fails to comply, the Landlord may pursue the remedies set forth in this Section against Tenant based on the Subcontractor's failure to comply, provided that Landlord has first provided Tenant with notice and an opportunity to obtain a cure of the violation.

(e) Tenant shall not discharge, reduce in compensation, or otherwise discriminate against any employee for notifying Landlord with regard to Tenant's noncompliance or anticipated noncompliance with the requirements of the HCAO, for opposing any practice proscribed by the HCAO, for participating

in proceedings related to the HCAO, or for seeking to assert or enforce any rights under the HCAO by any lawful means.

(f) Tenant represents and warrants that it is not an entity that was set up, or is being used, for the purpose of evading the intent of the HCAO.

(g) Tenant shall maintain employee and payroll records in compliance with the California Labor Code and Industrial Welfare Commission orders, including the number of hours each employee has worked on the Landlord Contract.

(h) Tenant shall keep itself informed of the current requirements of the HCAO.

(i) Tenant shall provide reports to the Landlord in accordance with any reporting standards promulgated by the Landlord under the HCAO, including reports on Subcontractors and Subtenants, as applicable.

(j) Tenant shall provide Landlord with access to records pertaining to compliance with HCAO after receiving a written request from Landlord to do so and being provided at least ten (10) business days to respond.

(k) Tenant shall allow Landlord to inspect Tenant's premises and have access to Tenant's employees in order to monitor and determine compliance with HCAO.

(l) Landlord may conduct random audits of Tenant to ascertain its compliance with HCAO. Tenant agrees to cooperate with Landlord when it conducts such audits.

(m) If Tenant is exempt from the HCAO when this Lease is executed because its amount is less than Twenty Five Thousand Dollars (\$25,000) (Fifty Thousand Dollars (\$50,000) for nonprofits), but Tenant later enters into an agreement or agreements that cause Tenant's aggregate amount of all agreements with Landlord to reach Seventy Five Thousand Dollars (\$75,000), all the agreements shall be thereafter subject to the HCAO. This obligation arises on the effective date of the agreement that causes the cumulative amount of agreements between Tenant and the Landlord to be equal to or greater than Seventy Five Thousand Dollars (\$75,000) in the fiscal year.

**17. Limitations on Contributions.** Through its execution of this Lease, Tenant acknowledges that it is familiar with the provisions of Article III, Chapter 2 of San Francisco's Campaign and Governmental Conduct Code, and Sections 87100 et seq. and Sections 1090 et seq. of the Government Code of the State of California, and certifies that it does not know of any facts which constitute a violation of said provisions and agrees that if it becomes aware of any such fact during the Term it shall immediately notify Landlord.

**18. Food Service Waste Reduction Ordinance.** San Francisco's Food Service Waste Reduction Ordinance, Ordinance No. 295-06, SF Environment Code Chapter 16 ("**Waste Reduction Ordinance**") requires restaurants, retail food vendors, City and County of San Francisco departments, City and County of San Francisco contractors and City and County of San Francisco lessees to use biodegradable/compostable or recyclable disposable food service ware when selling or distributing prepared foods, unless there is no "affordable" alternative. The Waste Reduction Ordinance also prohibits such businesses and the City and County of San Francisco from using disposable food service ware made from polystyrene (Styrofoam™). The parties agree that the Waste Reduction Ordinance applies to this Lease as if Landlord were the City and County of San Francisco for purposes of application of the law to



this Lease. Violation of the Waste Reduction Ordinance may result in contractual damages, a criminal fine, administrative penalty, or other civil enforcement action.

**19. Submitting False Claims; Monetary Penalties.** Pursuant to San Francisco Administrative Code Chapter 6, Article V, Tenant or any subcontractor or consultant who submits a false claim shall be liable to Landlord for three times the amount of damages which Landlord sustains because of the false claim, plus a civil penalty of up to Ten Thousand Dollars (\$10,000), and other damages as provided by statute. Landlord or any such subcontractor or consultant will be deemed to have submitted a false claim to Landlord if Tenant or such subcontractor or consultant (a) knowingly presents or causes to be presented to an officer or employee of Landlord a false claim or request for payment or approval; (b) knowingly makes, uses, or causes to be made or used a false record or statement to get a false claim paid or approved by Landlord; (c) conspires to defraud Landlord by getting a false claim allowed or paid by Landlord; (d) knowingly makes, uses, or causes to be made or used a false record or statement to conceal, avoid, or decrease an obligation to pay or transmit money or property to Landlord; or (e) is a beneficiary of an inadvertent submission of a false claim to Landlord, subsequently discovers the falsity of the claim, and fails to disclose the false claim to Landlord within a reasonable time after discovery of the false claim.

**20. Disallowance; Debarment.** If Tenant claims or receives payment from Landlord for a service, reimbursement for which is later disallowed by the State of California or United States Government, Tenant shall promptly refund the disallowed amount to Landlord upon Landlord's request. At its option, Landlord may offset the amount disallowed from any payment due or to become due to Tenant under this Lease or any other agreement. By executing this Lease, Tenant certifies that Tenant is not suspended, debarred or otherwise excluded from participation in federal assistance programs. Tenant acknowledges that this certification of eligibility to receive federal funds is a material term of the Lease.

**21. Sustainability.** Tenant acknowledges that the Center is or may be in the future certified/rated pursuant to or operated to meet one or more Green Building Standards. As and when requested by Landlord during the Term, Tenant shall provide Landlord (in the format requested by Landlord and reasonably necessary or desirable to comply with the requirements of the Center's Sustainability Practices, the applicable Green Building Standards or any commissioning or re-commissioning of any building systems) with data concerning Tenant's energy consumption, water consumption, waste recycling, and the operation of building systems. Such data may include, but shall not be limited to, Tenant's operating hours, the number of on-site personnel, the types of equipment used at the Center (including computer equipment, if applicable), office supply purchases, light bulb purchases, waste and recycling manifests (including gross waste generated and diverted to landfill), cleaning product materials (both chemicals and paper products), environmental characteristics (e.g. landscaping, bicycle racks), as applicable, and energy use and cost. Landlord shall have no liability to Tenant if, once obtained, any such Green Building Standards rating or certification lapses and is not reinstated by Landlord. Tenant and any occupants of the Premises shall comply with the Center's Sustainability Practices and the applicable Green Building Standards, if any. Tenant shall not materially, adversely affect (as reasonably determined by Landlord) the indoor air quality of the Premises or the Center, including by the type of equipment, furniture, furnishings, fixtures or personal property that is brought into the Premises, the materials used in the construction of any tenant improvements or Alterations in the Premises, the cleaning supplies used in the maintenance of the Premises, or the violation of any non-smoking policy adopted by Landlord. Landlord and Tenant agree to share data needed for third party rating systems such as LEED, GRESB and ENERGY STAR, and Tenant agrees that Landlord may provide data from Tenant to Landlord's consultants, lenders or prospective lenders, purchasers or prospective purchasers, or other third parties having a reasonable need to know such information.

As used in this Lease, the term “**Center’s Sustainability Practices**” means the operations and maintenance practices for the Center, whether incorporated into the Center’s rules and regulations, construction rules and regulations, separate written sustainability policies or otherwise reasonably implemented by Landlord with respect to the Center, whether voluntary or required by applicable law, as the same may be revised from time to time, addressing, among other things: energy efficiency; energy measurement and reporting; water usage; recycling, composting, and waste management; indoor air quality; and chemical use. As used in this Lease, the term “**Green Building Standards**” means one or more of the following: the U.S. EPA’s Energy Star® Portfolio Manager, the Green Building Initiative’s Green Globes™ building rating system, the U.S. Green Building Council’s Leadership in Energy and Environmental Design (LEED®) building rating system, the ASHRAE Building Energy Quotient (BEQ), the Global Real Estate Sustainability Benchmark (GRESB), or other standard for high performance buildings adopted by Landlord with respect to the Center, as the same may be revised from time to time.

**22. Limitations on Contributions.** Through execution of the Lease, the Tenant acknowledges that it is familiar with Section 1.126 of the San Francisco Campaign and Governmental Conduct Code, which prohibits any person who contracts with Landlord for the rendition of personal services, for the furnishing of any material, supplies or equipment, or for the sale or lease of any land or building, from making any campaign contribution to (1) Landlord’s elective officers if the contract must be approved by the individual, a board on which that individual serves, or a board on which an appointee of that individual serves, (2) a candidate for the office held by such individual, or (3) a committee controlled by such individual, at any time from the commencement of negotiations for the contract until the later of either the termination of negotiations for such contract or six months after the date the contract is approved. Tenant acknowledges that the foregoing restriction applies only if the contract or a combination or series of contracts approved by the same individual or board in a fiscal year have a total anticipated or actual value of \$50,000 or more. Tenant further acknowledges that the prohibition on contributions applies to each prospective party to the contract; each member of Tenant’s board of directors; Tenant’s chairperson, chief executive officer, chief financial officer and chief operating officer; any person with an ownership interest of more than 20 percent in Tenant; any subcontractor listed in the bid or contract; and any committee that is sponsored or controlled by Tenant. Additionally, Tenant acknowledges that Tenant must inform each of the persons described in the preceding sentence of the prohibitions contained in Section 1.126.

**23. Consumption Data.** Tenant acknowledges that Landlord is or may become subject to certain energy disclosure requirements, which requirements, whether made pursuant to statute, ordinance and regulation or other applicable laws now existing or hereafter adopted, shall collectively be referred to herein as “**Required Energy Disclosures.**” Tenant authorizes Landlord to disclose information concerning energy use by Tenant, either individually or in combination with the energy use of other tenants, as applicable, in connection with any Required Energy Disclosures, whenever Landlord determines, in good faith, that such disclosure is reasonably necessary to comply with laws applicable to the Center or Landlord’s ownership thereof. If (i) any utility is billed directly to Tenant or any subtenant or licensee of Tenant or (ii) Landlord is not responsible for reading any submetered or separately metered utility supplied to the Premises, then Tenant shall, within thirty (30) days after request by Landlord, provide consumption data in a form reasonably required by Landlord. Further, if Tenant utilizes separate service providers from those of Landlord, Tenant hereby consents to Landlord obtaining the consumption data directly from such service providers and, within ten (10) days after written request, Tenant shall execute and deliver to Landlord and the service providers such written releases as the service providers may request evidencing Tenant’s consent to deliver the consumption data to Landlord. Landlord shall not be required to notify Tenant of the making of Required Energy Disclosures; provided, however, that to the extent disclosure to Tenant is required by applicable laws, such disclosure may be satisfied by making Required Energy Disclosures available for review by Tenant in the Center’s management office. Tenant

hereby releases Landlord from any claims, losses, costs, damages, expenses and liabilities arising out of, resulting from, or otherwise relating to the making of any Required Energy Disclosures.

24. **Labor Harmony.** Tenant acknowledge that it is of the utmost importance to Landlord and all those occupying or that will occupy space in the Center that there be no interruption or threat of interruption in the progress of the construction work. Tenant acknowledges that it has been advised by Landlord that the construction work on the Center is being conducted pursuant to a Project Labor Agreement (“PLA”) and that the PLA applies to certain Tenant Improvements, as set forth therein. Accordingly, Tenant agrees as follows:

(a) For Tenant Improvements to which the PLA applies (including under extensions of or amendments to the PLA pursuant to Section 25.2 of the PLA), Tenant shall ensure that each prime contractor executes the PLA.

(b) For Tenant Improvements to which the PLA does not apply:

(i) In any contract or undertaking which Tenant may make with a contractor for work in the Premises, provision shall be made for the dismissal from the job of workmen whose work is unskilled, in the Executive Director of the TJPA’s reasonable judgment. Tenant shall cause any such workmen to be discharged from the project within twenty-four (24) hours after the Executive Director gives notice to Tenant requiring such discharge.

(ii) Because work covered by the PLA and tenant work not covered by the PLA may, at various times, be taking place at the same times and in close proximity, it is imperative that the non-covered work not interfere with the PLA-covered work. Landlord must ensure that there are no disruptions in the construction project because of labor disputes and has concluded that other alternatives to this provision are not feasible to ensure labor harmony on the construction project. As an example, Landlord has considered the use of dual gate systems; however, the geographical configuration of the project will be restrictive in size and access, and therefore, dual gate systems would not be feasible and/or safe for the workers and the general public.

(iii) Tenant shall use, and Tenant shall require its contractor and subcontractors to use, their respective best efforts to prevent labor disputes and/or work stoppages on the Premises, and/or elsewhere on the Center and related structures, to the extent attributable to work being performed on the Premises, irrespective of the reason of any such labor dispute or work stoppages. In the event that the conduct or presence of any employee(s) of Tenant or Tenant’s contractor(s) or subcontractor(s) causes a labor dispute, work stoppage or threatened labor dispute or work stoppage, Tenant shall remove such employee(s) immediately from the terminal upon Executive Director’s request. If Tenant refuses to substitute another contractor or subcontractor who will not cause or will not threaten to cause a labor dispute on the Center to complete the work in question, then Tenant agrees that in the discretion of the Executive Director, all such tenant improvement work must cease until such time as the construction work on all portions, sections or segments of Phase I of the Center is deemed complete and turned over to Landlord pursuant to Article 26 of the PLA.

(iv) Tenant shall include, and shall cause its contractor to include, the following clause in all contracts entered into with its general contractors and subcontractors for work performed at the Center:

Harmony Clause

There shall be no manifestations on the project of any dispute between any labor organization and any Tenant contractor or subcontractor, including but not limited to, any area standards picketing, bannering or handbilling against said contractor or subcontractor. Should there be any manifestation of a labor dispute between any Tenant contractor or subcontractor and any union, which results in a stoppage of work or threatened stoppage of work on the part of said contractor or subcontractor's employees or the employees of any other employer or supplier on the project or at the Center, which in the sole judgment of the Executive Director of the Landlord will cause, or is likely to cause, unreasonable delay in the progress of construction or operation of any business at the Center, then upon written notice from Executive Director, Tenant shall declare the contractor or subcontractor in default of its contract, and upon such notice, Tenant shall have the right to take such steps as are necessary to finish the uncompleted portion of the work to be performed by the contractor or subcontractor.

(e) Without limiting the generality of indemnities elsewhere in this Lease, Tenant shall indemnify, defend, and hold harmless the TJPA and each related Entity for any and all losses which arise from the actions taken pursuant to this Section.

SCHEDULE 1 TO  
GOVERNMENT REQUIREMENTS

ACCESS NOTICE

**DISABILITY ACCESS OBLIGATIONS NOTICE**

SAN FRANCISCO ADMINISTRATIVE CODE CHAPTER 38

---

Before you, as the Tenant, enter into a lease with us, the Landlord, for the following property [INSERT DESCRIPTION/ADDRESS] (the "Property"), please be aware of the following important information about the lease:

**You May Be Held Liable for Disability Access Violations on the Property.** Even though you are not the owner of the Property, you, as the tenant, as well as the Property owner, may still be subject to legal and financial liabilities if the leased Property does not comply with applicable Federal and State disability access laws. You may wish to consult with an attorney prior to entering this lease to make sure that you understand your obligations under Federal and State disability access laws. The Landlord must provide you with a copy of the Small Business Commission Access Information Notice under Section [38.6](#) of the Administrative Code in your requested language. For more information about disability access laws applicable to small businesses, you may wish to visit the website of the San Francisco Office of Small Business or call 415-554-6134.

**The Lease Must Specify Who Is Responsible for Making Any Required Disability Access Improvements to the Property.** Under City law, the lease must include a provision in which you, the Tenant, and the Landlord agree upon your respective obligations and liabilities for making and paying for required disability access improvements on the leased Property. The lease must also require you and the Landlord to use reasonable efforts to notify each other if they make alterations to the leased Property that might impact accessibility under federal and state disability access laws. You may wish to review those provisions with your attorney prior to entering this lease to make sure that you understand your obligations under the lease.

By signing below I confirm that I have read and understood this Disability Access Obligations Notice.

Signed: \_\_\_\_\_, Tenant

Signed: \_\_\_\_\_, Landlord

(c) If the Commercial Landlord does not ensure that existing public restrooms, ground floor entrances, and ground floor exits are accessible as provided in subsection (a)(1) and instead proceeds under subsection (a)(2), the Commercial Landlord shall include the following statement in Disability Access Obligations Notice required under subsection (b):

"PLEASE NOTE: The Property may not currently meet all applicable construction-related accessibility standards, including standards for public restrooms and ground floor entrances and exits."

(d) The Commercial Landlord must sign, and obtain the Small Business Tenant's signature on, the Disability Access Obligations Notice under subsections (b) and (c) on or before execution or amendment of the Lease and shall provide the tenant with a copy of the Small Business Commission's Access Information Notice as defined under Section [38.6](#) in the tenant's requested language.

---

Chapter 38 applies to Leases of property of 7,500 – 5001 square feet of space, and to the parties to those leases, entered into, or amended, on or after January 1, 2013, and on or after June 1, 2013 expanding to Leases of properties of 5000 square feet of space or less.

Version 3: 5.23.2013

SCHEDULE 2 TO  
GOVERNMENT REQUIREMENTS

CARD CHECK POLICY

*[see attached]*

# TRANSBAY JOINT POWERS AUTHORITY

Board Policy No. 011

Category: Workplace Matters

## LABOR REPRESENTATION POLICY

### I. DEFINITIONS. FOR PURPOSES OF THIS POLICY, THE FOLLOWING DEFINITIONS SHALL APPLY

A. "Card check agreement" means a written agreement between an employer and a labor organization providing a procedure for determining employee preference on the subject of whether to be represented by a labor organization for collective bargaining, and if so, by which labor organization to be represented, which provides, at a minimum, the following:

1. Determining employee preference regarding union representation shall be by a card check procedure conducted by a neutral third party in lieu of a formal election;

2. All disputes over interpretation or application of the parties' card check agreement, and over issues regarding how to carry out the card check process or specific card check procedures shall be submitted to binding arbitration;

3. Forbearance by any labor organization from economic action against the employer at the worksite of an organizing drive covered by this Policy, and in relation to an organizing campaign only (not to the terms of a collective bargaining agreement), so long as the employer complies with the terms of the card check agreement;

4. Language and procedures prohibiting the labor organization or the employer from coercing or intimidating employees, explicitly or implicitly, in selecting or not selecting a bargaining representative.

B. "Contract" means a lease, management agreement, service agreement, loan, bond, guarantee, or other similar agreement in which one party is anyone operating a hotel or restaurant project.

C. "Collective bargaining agreement" means an agreement between an employer and a labor organization regarding wages, hours and other terms and conditions of employment of the employer's employees. For purposes of this Policy, a collective bargaining agreement does not include a card check agreement as defined herein.

D. "Developer" means any person, corporation, association, general or limited partnership, limited liability company, joint venture or other entity which does or which proposes to purchase, lease, develop, build, remodel or otherwise establish a hotel or restaurant project.

Adopted: 7/20/06

E. "Economic action" means concerted action initiated or conducted by a labor union and/or employees acting in concert therewith, to bring economic pressure to bear against an employer, as part of a campaign to organize employees or prospective employees of that employer, including such activities as striking, picketing, or boycotting.

F. "Employer" means any developer, manager/operator or subcontractor who employs individuals in a hotel or restaurant in a hotel or restaurant project.

G. "Hotel or restaurant project" means a development project or facility within the Transbay Transit Center or Transit Tower which contains a hotel or restaurant. For purposes herein a "hotel" shall mean any use or facility falling within either definition of Section 314.1(g) or (h) of the San Francisco Planning Code. For purposes herein a "restaurant" shall mean any facility that has as its principal purpose the sale of food and beverage for primarily on-site consumption, including any such facility operating within or as part of another facility, such as a hotel or retail store.

H. "Labor organization" means any organization of any kind, or any agency or employee representation committee or plan, in which employees participate and which exists for the purpose, in whole or in part, of dealing with employers concerning grievances, labor disputes, wages, rates of pay, hours of employment, or conditions of work.

I. "Manager/operator" means any person, corporation, association, limited or general partnership, joint venture or other entity (including a developer) that operates or manages a hotel or restaurant in a hotel or restaurant project, or provides any material portion of the services provided by such hotel or restaurant in a hotel or restaurant project.

J. "Subcontract" means any lease, sublease, management agreement or other similar agreement between a developer or a manager/operator and a subcontractor which contemplates or permits the subcontractor to operate or manage all or a portion of a hotel or restaurant in a hotel or restaurant project.

K. "Subcontractor" means any person, corporation, association, limited or general partnership, limited liability company, joint venture or other entity that enters into a subcontract with a developer or manager/operator.

## II. POLICY, REQUIREMENTS AND PROCEDURES TO MINIMIZE LABOR/MANAGEMENT CONFLICT

A. General Policy. The Board of Directors declares as a matter of general policy that employers operating a hotel or restaurant in a hotel or restaurant project within the Transbay Transit Center or Transit Tower shall agree to abide by the procedures of a card check agreement for determining employee preference on the subject of labor union representation, as specified in this Policy.

B. Pursuant to this Policy, the following requirements are imposed, except that no Employer, Developer or Manager/Operator, however, shall be responsible for obligations under this Policy if that person or entity is otherwise exempt from those obligations as described below.



1. Employers. An employer of employees working in a hotel or restaurant in a hotel or restaurant project within the Transbay Transit Center or Transit Tower shall:

a. Enter into a card check agreement with a labor organization which requests such an agreement for the purpose of seeking to represent those employees before executing the subcontract or contract pursuant to which it will operate a hotel or restaurant in a hotel or restaurant project;

b. If the parties are unable to agree to the terms of a card check agreement within 60 days of the commencement of such negotiations, they must enter into expedited binding arbitration in which the terms of a card check agreement will be imposed by an arbitrator. In such proceedings, to be conducted by an experienced labor arbitrator selected as provided by the rules of the American Arbitration Association or equivalent organization, the arbitrator shall consider any model card check agreement provided by the TJPA and/or prevailing practices and the terms of card check agreements in the same or similar industries, except that such card check agreement must include the mandatory terms identified in this Policy;

c. Comply with the terms of that card check agreement and this Policy;

d. Include in any subcontract (with a subcontractor) which contemplates or permits a Subcontractor to operate or manage a hotel or restaurant in a Hotel or Restaurant Project within the Transbay Transit Center or Transit Tower or to provide a service essential to the operation of such a hotel or restaurant, a provision requiring that subcontractor to comply with this Policy. This provision shall be a material and mandatory term of such subcontract, binding on all successors and assigns, and shall state (modified as necessary to accommodate particular circumstances):

"The Transbay Joint Powers Authority has a Policy which may apply to [Subcontractor]. Its terms are expressly incorporated by reference hereto. To the extent [Subcontractor] or its successors or assigns employs employees in a hotel or restaurant in [this facility] within the scope of that Policy, [Subcontractor] hereby agrees as a material condition of this [Subcontract] to enter into and abide by a card check agreement with a Labor Organization or Organizations seeking to represent [Subcontractor's] employees, if and as required by that Policy. [Subcontractor] recognizes that, as required by that Policy, it must enter into a card check agreement with a Labor Organization(s) as specified by that Policy before executing this [Subcontract], and that being party to such a card check agreement(s) is a condition precedent of rights or obligations under this [Subcontract]."

Notwithstanding the requirements provided in (a) - (d), any employer who has in good faith fully complied with those requirements will be excused from further compliance as to a labor organization which has taken economic action against that employer at that site in furtherance of a campaign to organize that employer's employees at that site for collective bargaining. This clause shall not be interpreted, however, to apply to economic action against an employer at other locations where that employer does business, or at any location for purposes other than organizing the employer's employees; nor shall economic action by one labor

organization excuse an employer from the obligations of this Policy or a card check agreement as to a different labor organization.

2. Developers and Manager/Operators. Any developer or manager/operator of a hotel or restaurant project must:

a. To the extent it employs employees in a hotel or restaurant in a hotel or restaurant project, abide by the requirements stated in Subsection (1);

b. Include the provision specified in (1)(d) in any subcontract, modified as necessary to accommodate the circumstances of that particular subcontract;

c. Refrain from executing a subcontract by which an employer subject to (1) is authorized or permitted to operate a hotel or restaurant in a hotel or restaurant project until that employer has entered into a card check agreement with a labor organization, as required in (1);

d. Notify local labor council(s) and/or federation(s) of any hotels(s) or restaurant(s) and/or any employer(s) that will operate a hotel or restaurant in a hotel or restaurant project within the Transbay Transit Center or Transit Tower which may be subject to the requirements of (1), as soon as the developer or manager/operator identifies such hotel(s) or restaurant(s) or employer(s), but in no event later than 21 days before requiring an employer to sign a subcontract. This notification requirement applies only to hotels or restaurants or employers that will operate in a Hotel or Restaurant Project.

e. Inform any prospective subcontractor, that if the subcontractor acts as an employer subject to the requirements of (1), it must enter into a card check agreement pursuant to this Policy before it may execute the subcontract, and as a condition precedent to any rights or obligations under such document;

f. Take reasonable steps to enforce the terms of any subcontract requiring compliance with this Policy.

3. The TJPA.

a. TJPA Contracts. This Policy shall be included and incorporated in any contract entered into by the TJPA which contemplates the use or operation of a hotel or restaurant in a hotel or restaurant project within the Transbay Transit Center or Transit Tower. Such contract shall state that any developer or operator/manager of a hotel or restaurant project within the Transbay Transit Center or Transit Tower, and any employer(s) operating in such hotel or restaurant project, agree to comply with this Policy as essential consideration for the TJPA entering into the contract, and that failure to comply with this policy shall constitute a material breach of the contract.

b. Executive Director Authority to Issue Implementation Guidelines. To facilitate the requirements imposed by this Section, the TJPA may provide a model recommended card check agreement that includes the mandatory terms identified in this Policy and which provides the maximum protection against labor/management conflict arising out of an

organizing drive, and make such model recommended agreement available to parties required to enter into such agreement. The TJPA's Executive Director, or designee, may also prepare guidelines establishing standards and procedures related to this Policy.

### III. SCOPE AND EXEMPTIONS

A. Scope. This Policy is not intended to favor any particular outcome in the determination of employer preference regarding union representation, nor to skew the procedures in such a determination to favor or hinder any party to such a determination. Likewise, this Policy is not intended to enact or express any generally applicable policy regarding labor/management relations, or to regulate those relations in any way. The requirements of this Policy apply only to the procedures for determining employee preference regarding whether to be represented by a labor organization for purposes of collective bargaining and/or by which labor organization to be represented. Accordingly, this Policy does not apply to the process of collective bargaining in the event a labor organization has been recognized as the bargaining representative for employees of employers subject to this Policy. Moreover, nothing in the Policy requires an employer or other entity subject to this Policy to recognize a particular labor organization; nor does any provision of this Policy require that a collective bargaining agreement be entered into with any labor organization, or that an employer submit to arbitration regarding the terms of a collective bargaining agreement.

B. Exemptions. The requirements of this Policy shall not apply to:

1. Employers employing fewer than the equivalent of 50 full-time or part-time employees, provided that when a restaurant is located on the same premises as a hotel and routinely provides food or beverage services to the hotel's guests, employees of the restaurant and hotel shall be aggregated for purposes of determining the applicability of this ordinance;
2. Any employer which is signatory to a valid and binding collective bargaining agreement covering the terms and conditions of employment for its employees at that hotel or restaurant project, or which has entered into a card check agreement with a labor organization regarding such employees which agreement provides at least equal protection, as determined by the Executive Director of the TJPA, from labor/management conflict as provided by this Policy;
3. Any hotel or restaurant project where the developer, manager/operator or employer, is an agency of the federal government or a statewide agency or entity ("public agency") and that public agency would prohibit application of this Policy; or
4. Any hotel or restaurant project where the requirements of this Policy would violate or be inconsistent with the terms or conditions of a grant, subvention or agreement with a public agency related to such hotel or restaurant project, or any related rules or regulations.

EXHIBIT G

FORM OF COMMENCEMENT DATE CERTIFICATE

This Commencement Date Certificate is entered into as of \_\_\_\_\_, 20\_\_ by and between Transbay Joint Powers Authority, a joint exercise of powers agency duly created and existing under the Joint Exercise of Powers Act of the State of California, California Government Code Sections 6500 et seq. ("Landlord"), and Spring Fertility Management, LLC ("Tenant"), with reference to the following facts:

A. Landlord and Tenant entered into that certain Retail Lease dated as of \_\_\_\_\_, 2019 for premises located in the center known as the Salesforce Transit Center in San Francisco, California (the "Lease");

B. The parties now wish to confirm the Commencement Date and the Expiration Date (as those terms are defined in the Lease).

NOW, THEREFORE, for good and valuable consideration, the receipt and sufficiency of which is hereby acknowledged, Landlord and Tenant agree as follows:

1. The Commencement Date of the Lease is \_\_\_\_\_, 20\_\_.
2. The Expiration Date of the Lease is \_\_\_\_\_, 20\_\_.
3. The Lease, as modified by this Commencement Date Agreement, is hereby ratified in all respects and shall remain in full force and effect in accordance with its terms.

IN WITNESS WHEREOF, Landlord and Tenant have each executed this Commencement Date Certificate as of the date first written above.

LANDLORD

TENANT

TRANSBAY JOINT POWERS AUTHORITY

Spring Fertility Management, LLC,  
a \_\_\_\_\_

By: \_\_\_\_\_

By: \_\_\_\_\_

Name: \_\_\_\_\_

Name: \_\_\_\_\_

Its: \_\_\_\_\_

Its: \_\_\_\_\_

EXHIBIT H

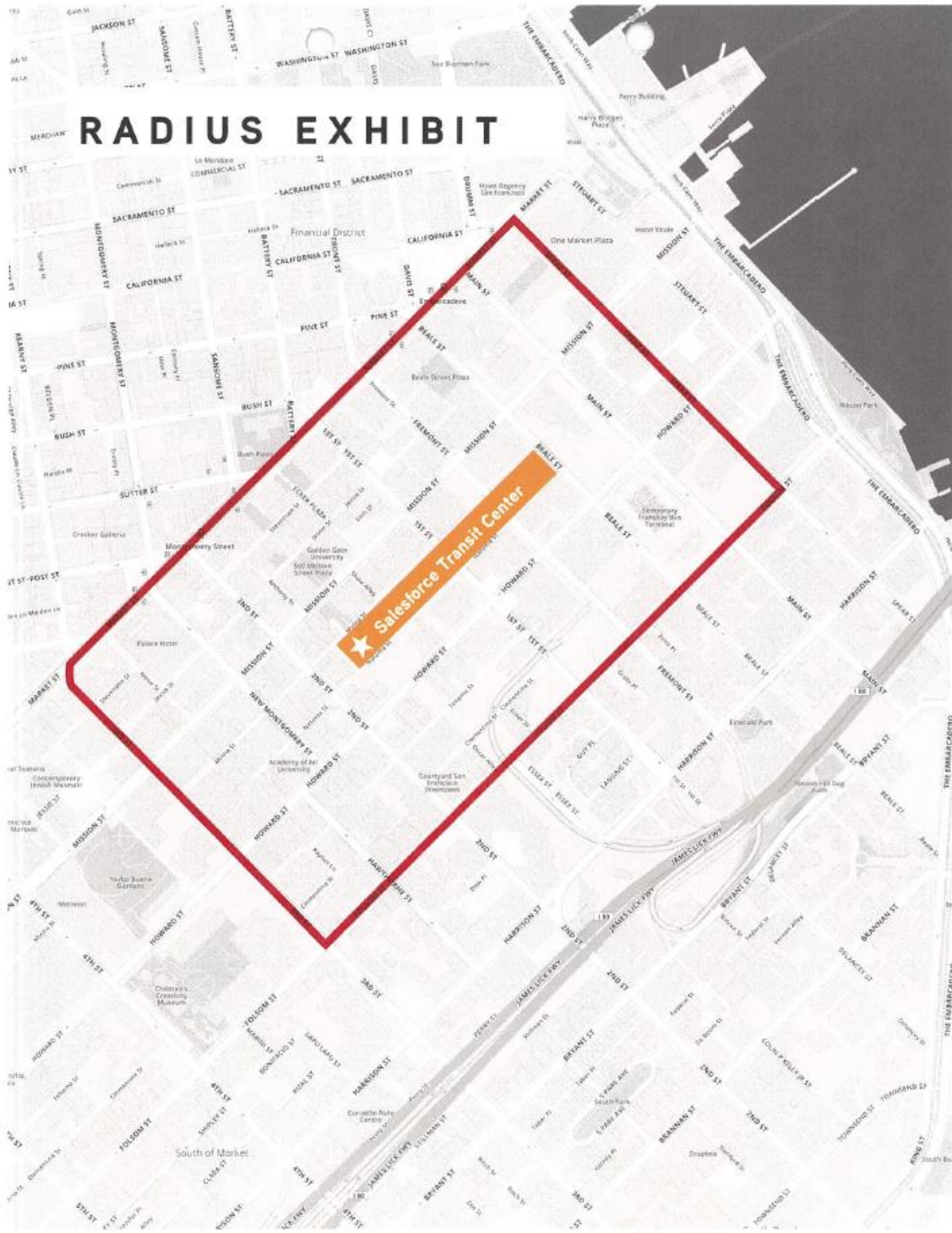
LIST OF RESTRICTIONS

Under no circumstances whatsoever may the Premises be used for any of the following businesses or activities:

1. A health club providing health club services and related activities to the public such as Yoga, personal training and nutritional counseling.
2. A primary business of a general medical office providing medical services consistent with those services offered by a general practitioner.
3. A primary business of (need Fave language)

EXHIBIT I

RADIUS



## EXHIBIT J

### FORM OF GUARANTY

This GUARANTY (this “**Guaranty**”) is made and entered into by James Deng, an individual (“**Guarantor**”), in favor of TRANSBAY JOINT POWERS AUTHORITY, a joint exercise of powers agency duly created and existing under the Joint Exercise of Powers Act of the State of California, California Government Code Sections 6500 et seq. (“**Landlord**”), in connection with that certain Retail Lease Agreement, dated \_\_\_\_\_, 2019 (the “**Effective Date**”) and entered into by and between Spring Fertility Management, LLC (“**Tenant**”), and Landlord concurrently with this Guaranty (the “**Lease**”), pursuant to which Tenant leases from Landlord certain premises (as more particularly defined in the Lease) (“**Premises**”) within the Salesforce Transit Center located in San Francisco, California. Terms used herein with initial capital letters not conforming to customary English language usage shall have the meaning ascribed to such terms in the Lease.

As a material inducement to and in consideration of Landlord entering into the Lease (Landlord having indicated that it would not enter into the Lease without the execution of this Guaranty), Guarantor hereby covenants and agrees as follows:

1. Guarantor unconditionally and irrevocably guarantees, as a primary obligor and not as a surety, the full, faithful and timely payment, performance and observance of any and all obligations and liabilities of Tenant under the Lease (collectively, the “**Guaranteed Obligations**”).
2. Guarantor agrees that, without the consent of, or notice to, Guarantor and without affecting any of the obligations of Guarantor under this Guaranty: (a) Landlord and Tenant may amend, compromise, release, or otherwise alter any term, covenant, or condition of the Lease, and Guarantor guarantees and promises to perform all the Guaranteed Obligations as so amended, compromised, released, or altered; (b) Landlord may release, substitute, or add any guarantor of or party to the Lease; (c) Landlord may exercise, not exercise, impair, modify, limit, destroy, or suspend any right or remedy of Landlord under the Lease; (d) Landlord or any other person acting on Landlord's behalf may deal in any manner with Tenant, any guarantor, any party to the Lease, or any other person; and (e) Landlord may permit all or any part of the rights or liabilities of Tenant under the Lease to be assigned, or assumed in accordance with the terms set forth in the Lease. This is a continuing guaranty, and Guarantor waives the benefit of the provisions of California Civil Code §2815.
3. Guarantor waives and agrees not to assert or take advantage of: (a) any right to require Landlord to proceed against Tenant or any other person, or to pursue any other remedy before proceeding against Guarantor; (b) any right or defense that may arise by reason of the incapacity, lack of authority, death, or disability of Tenant or any other person; (c) any right or defense arising by reason of the absence, impairment, modification, limitation, destruction, or cessation (in bankruptcy, by an election of remedies, or otherwise) of the liability of Tenant, of the subrogation rights of Guarantor, or of the right of Guarantor to proceed against Tenant for reimbursement; and (d) the benefit of any statute of limitations affecting the liability of Guarantor under this Guaranty or the enforcement of this Guaranty. Without in any manner limiting the generality of the foregoing, Guarantor waives the benefits of the provisions of California Civil Code §§2809-2810, 2819, 2820, 2821, 2839, 2845, 2847, 2848, 2849-2850 and 2855 and any similar or analogous statutes of California or any other jurisdiction. In addition, Guarantor waives and agrees not to assert or take advantage of any right or defense based on the absence of any or all presentments, demands (including demands for performance), notices (including notices of adverse change in the financial status of Tenant or other facts that increase the risk to Guarantor, notices of nonperformance, and notices of acceptance of this Guaranty), and protests of each and every kind.
4. Until all of the Guaranteed Obligations are fully performed, Guarantor (a) will have no right of subrogation against Tenant by reason of any payments or acts of performance by Guarantor under this

Guaranty and (b) subordinates any liability or indebtedness of Tenant now or hereafter held by Guarantor to Tenant's obligations under, arising out of, or related to the Guaranteed Obligations.

5. The liability of Guarantor and all rights, powers, and remedies of Landlord under this Guaranty and under any other agreement now or at any time hereafter in force between Landlord and Guarantor relating to the Lease will be cumulative and not alternative, and such rights, powers, and remedies will be in addition to all rights, powers, and remedies given to Landlord by law or in equity.

6. This Guaranty applies to, inures to the benefit of, and binds all parties to this Guaranty, their heirs, devisees, legatees, executors, administrators, representatives, successors, and assigns (including any purchaser at a judicial foreclosure or trustee's sale or a holder of a deed in lieu of foreclosure). This Guaranty may be assigned by Landlord voluntarily or by operation of law.

7. Guarantor will not, without the prior written consent of Landlord, commence (or join with any other person in commencing) any bankruptcy, reorganization, or insolvency proceeding against Tenant. The obligations of Guarantor under this Guaranty will not be altered, limited, or affected by any proceeding, voluntary or involuntary, involving the bankruptcy, insolvency, receivership, reorganization, liquidation, or arrangement of Tenant, or by any defense that Tenant may have by reason of any order, decree, or decision of any court or administrative body resulting from any such proceeding. Unless and until all of the Guaranteed Obligations are fully performed, Guarantor will file in any bankruptcy, or other proceeding in which the filing of claims is required or permitted by law, all claims that Guarantor may have against Tenant relating to any indebtedness of Tenant to Guarantor, and Guarantor will assign to Landlord all rights of Guarantor under these claims. Landlord will have the sole right to accept or reject any plan proposed in such proceeding and to take any other action that a party filing a claim is entitled to take. In all such cases, whether in administration, bankruptcy, or otherwise, the person or persons authorized to pay such claim will pay to Landlord the amount payable on such claim and, to the full extent necessary for that purpose, Guarantor assigns to Landlord all of Guarantor's rights to any such payments or distributions to which Guarantor would otherwise be entitled; provided that Guarantor's obligations under this Guaranty will not be satisfied except to the extent that Landlord receives cash by reason of any such payment or distribution. If Landlord receives anything other than cash, it will be held as collateral for amounts due under this Guaranty.

8. TO THE EXTENT NOW OR HEREAFTER PERMITTED BY LAW, GUARANTOR WAIVES THE RIGHT TO A JURY TRIAL OF ANY CAUSE OF ACTION, CLAIM, COUNTERCLAIM, OR CROSS-COMPLAINT IN ANY ACTION, PROCEEDING, OR OTHER HEARING BROUGHT BY EITHER LANDLORD AGAINST TENANT OR GUARANTOR, OR BY TENANT OR GUARANTOR AGAINST LANDLORD, ON ANY MATTER ARISING OUT OF, OR IN ANY WAY CONNECTED WITH, THE LEASE, THIS GUARANTY, THE RELATIONSHIP OF LANDLORD AND TENANT, TENANT'S MANAGEMENT OR OPERATION OF THE PREMISES, OR ANY CLAIM OF INJURY OR DAMAGE, OR THE ENFORCEMENT OF ANY REMEDY UNDER ANY LAW, STATUTE, OR REGULATION, EMERGENCY OR OTHERWISE, NOW OR HEREAFTER IN EFFECT.

9. As a further material part of the consideration to Landlord to enter into the Lease with Tenant, (a) Guarantor agrees that the law of the State of California will govern all questions with respect to the Guaranty, (b) Guarantor agrees that any suit, action, or proceeding arising directly or indirectly from the Guaranty, the Lease, or the subject matter of either will be litigated only in courts located within the City and County of San Francisco, California, (c) Guarantor irrevocably consents to the jurisdiction of any local, state, or federal court located within the City and County of San Francisco, California, and (d) without limiting the generality of the foregoing, Guarantor waives and agrees not to assert by way of motion, defense, or otherwise in any suit, action, or proceeding any claim that Guarantor is not personally subject to the jurisdiction of the above-named courts, that such suit, action, or proceeding is brought in an inconvenient forum, or that the venue of such action, suit, or proceeding is improper.



10. If a claim (a “**Claim**”) is made on Landlord at any time (whether before or after payment or performance in full of any obligation of Guarantor, and whether such claim is asserted in a bankruptcy proceeding or otherwise) for repayment or recovery of any amount or other value received by Landlord (from any source) in payment of, or on account of, any obligation of Guarantor under this Guaranty, and if Landlord repays such amount, returns value, or otherwise becomes liable for all or part of such Claim by reason of (a) any judgment, decree, or order of any court or administrative body or (b) any settlement or compromise of such Claim, then Guarantor will remain severally liable to Landlord for the amount so repaid or returned or for which Landlord is liable to the same extent as if such payments or value had never been received by Landlord, despite any termination of this Guaranty, termination of the Lease, or cancellation of any document evidencing any obligation of Guarantor under this Guaranty.

11. This Guaranty will constitute the entire agreement between Guarantor and Landlord with respect to the subject matter of this Guaranty and supersedes all prior agreements, understandings, negotiations, representations, and discussions, whether verbal or written, of the parties, pertaining to that subject matter. Guarantor is not relying on any representations, warranties, or inducements from Landlord that are not expressly stated in this Guaranty.

12. No provision of this Guaranty or right of Landlord under it may be waived, nor may any Guarantor be released from any obligation under this Guaranty except by a writing duly executed by an authorized officer or director of Landlord.

13. When the context and construction so requires, all words used in the singular in this Guaranty will be deemed to have been used in the plural. The word "person" as used in this Guaranty will include an individual, company, firm, association, partnership, corporation, trust, or other legal entity of any kind whatsoever. "Landlord," whenever used in this Guaranty, refers to and means the Landlord under the Lease specifically named and also any assignee of Landlord, whether by outright assignment or by assignment for security, and also any successor to the interest of Landlord or of any assignee of the Lease or any part of the Lease, whether by assignment or otherwise. "Tenant," whenever used in this Guaranty, refers to and means Tenant under the Lease and also any assignee of the interest of Tenant in the Lease and their respective successors in interest.

14. If any provision of this Guaranty is determined to be illegal or unenforceable, all other provisions will nevertheless be effective.

15. The waiver or failure to enforce any provision of this Guaranty will not operate as a waiver of any other breach of such provision or any other provisions of this Guaranty; nor will any single or partial exercise of any right, power, or privilege preclude any other or further such exercise or the exercise of any other right, power, or privilege.

16. Time is strictly of the essence under this Guaranty and any amendment, modification, or revision of this Guaranty.

17. If Guarantor is a corporation, limited liability company, partnership, or other entity, then each individual executing this Guaranty on behalf of that entity represents and warrants that he or she is duly authorized to execute and deliver this Guaranty on behalf of the entity in accordance with its governing documents, and that this Guaranty is binding on the entity in accordance with its terms.

18. Guarantor represents and warrants to Landlord that: (a) as of the date hereof, and after giving effect to this Guaranty and the contingent obligations evidenced hereby, Guarantor (i) is, and intends to be, solvent, (ii) has and intends to maintain assets which, fairly valued, exceed its obligations, liabilities (including contingent liabilities) and debts, and (iii) has and intends to have property and assets sufficient to satisfy and repay its obligations, liabilities (including contingent liabilities) and debts, including, without limitation, the Guaranteed Obligations; and (b) there is no existing or, to Guarantor’s knowledge

after diligent inquiry, pending or threatened claim, litigation, suit, action, or proceeding before any court or administrative agency affecting Guarantor that would, if adversely determined, materially adversely affect Guarantor's ability to perform under this Guaranty.

19. Guarantor further represents and warrants to Landlord that: (a) Guarantor has full right, title, authority and capacity to execute and perform this Guaranty; (b) the execution and delivery of this Guaranty have been duly authorized by all requisite actions of Guarantor; (c) this Guaranty constitute the valid, binding, and enforceable obligations of Guarantor; and (d) neither the execution of this Guaranty nor the consummation of the transactions the same contemplate violates, or will result in any breach of, or constitute a default under, any agreement (including Guarantor's organizational documents), mortgage, deed of trust, lease loan, credit agreement, partnership agreement, or other contract, restriction or instrument to which Guarantor is a party or by which Guarantor may be bound.

20. Guarantor represents and warrants that it is familiar with, and has independently reviewed books and records regarding, the financial condition of Tenant.

21. Guarantor represents and warrants that neither Landlord nor any other party has made any representation, warranty or statement to Guarantor in order to induce Guarantor to execute this Guaranty.

22. If either party to this Guaranty participates in an action against the other party arising out of or in connection with this Guaranty, the prevailing party will be entitled to have and recover from the other party reasonable attorney fees, collection costs, and other costs incurred in, and in preparation for, the action, arbitration, or mediation.

23. Any notice, request, demand, instruction, or other communication to be given to any party under this Guaranty must be in writing and must be delivered in the manner provided in the Lease for delivery of notices (and will be deemed delivered in accordance with the time periods set forth in the Lease) and addressed to the party to be notified at the address set forth below, or to such other place as the party to be notified may from time to time designate by at least fifteen (15) days' notice to the notifying party.

If to Landlord:

Transbay Joint Powers Authority  
425 Mission Street, Suite 250  
San Francisco, CA 94105  
Attn: Facility Manager  
Facsimile: (415) 597-4615

with a copy to:

LPC West Transit Management LLC  
915 Wilshire Boulevard, Suite 1950  
Los Angeles, CA 90017  
Attention: Ginger Dunbar  
Facsimile: (213) 542-8241  
E-mail: GDunbar@LPC.com

If to Guarantor:

Derald Sue

\_\_\_\_\_

\_\_\_\_\_

Tel: \_\_\_\_\_

24. If Guarantor is more than one (1) person, the obligations of the persons comprising Guarantor will be joint and several and the unenforceability of this Guaranty or Landlord's election not to enforce this Guaranty against one (1) or more of the persons comprising Guarantor will not affect the obligations of the remaining persons comprising Guarantor or the enforceability of this Guaranty against such remaining persons.

25. Guarantor covenants and agrees to execute such other and further documents and do such further acts as may be reasonably required to effectuate the intent of the parties and carry out the terms of this Guaranty.

GUARANTOR

---

DERALD SUE

***[NTD: GUARANTOR TO CONFIRM WHETHER HE IS MARRIED; IF HE IS MARRIED A SPOUSAL CONSENT TO THE GUARANTY WILL BE REQUIRED]***

EXHIBIT K

SIGNAGE

[to be attached]

## ADDENDUM TO SALESFORCE TRANSIT CENTER LEASE

### OPTION TO EXTEND TERM

This Addendum to Salesforce Transit Center Lease (this “**Addendum**”) is made and entered into by and between the Transbay Joint Powers Authority, a joint exercise of powers agency duly created and existing under the Joint Exercise of Powers Act of the State of California, California Government Code Sections 6500 et seq. (“**Landlord**”) and Spring Fertility Management, LLC (“**Tenant**”), and is dated as of the Lease Date set forth in the Basic Lease Information of the Salesforce Transit Center Lease between Landlord and Tenant to which this Addendum is attached (the “**Base Lease**”). Capitalized terms used herein and not otherwise defined shall have the meanings given those terms in the Base Lease. As used in this Addendum, the term “**Lease**” means the Base Lease as modified by this Addendum.

Tenant is given the option to extend the Term of the Lease for two (2) additional consecutive periods of five (5) years each (the “**Option Term**”) following expiration of the initial term stated in the Basic Lease Information (the “**Initial Term**”) or the immediately preceding Option Term, as applicable, by giving written notice of exercise of such option (the “**Option Notice**”) to Landlord not less than twelve (12) but not more than twenty-four (24) months before the expiration of the Initial Term or immediately preceding Option Term, as applicable. The options to extend the Term under this Addendum are personal to the original Tenant named herein and may be exercised only by the original Tenant named herein while occupying the Premises without the intent to thereafter effect a Transfer and may not be exercised or assigned, voluntarily or involuntarily, to any person or entity. Notwithstanding the foregoing, if Tenant is in default under the Lease either on the date of giving an Option Notice or on the date an Option Term is to commence, then, at Landlord’s option, Tenant shall have no right to extend the Term and the Lease shall expire at the end of the Initial Term or the end of the immediately preceding Option Term, as applicable. The monthly Base Rent for the first (1<sup>st</sup>) year of the Option Term shall be equal to the fair market rental (“**Fair Market Rental**” as hereinafter defined) of the Premises at the commencement of the Option Term (the “**Adjustment Date**”). On the first (1<sup>st</sup>) anniversary of the Adjustment Date and on each subsequent anniversary of the Adjustment Date occurring during the applicable Option Term, the Base Rental shall be increased to an amount equal to the product of (x) 1.03 and (y) the Base Rent in effect for the preceding year.

As used in the Addendum, “**Fair Market Rental**” shall mean the rate being charged to retail tenants renewing existing leases for comparable space in the City and County of San Francisco, California, with similar amenities, taking into consideration only the following: size, location, proposed term of the lease, extent of services to be provided and the time that the particular rate under consideration became or is to become effective. In determining the “**Fair Market Rental**”, no consideration shall be given to payment of leasing commissions, tenant improvement allowances, “free rent” or any other terms or conditions of leases of comparable space. Fair Market Rental as of the Adjustment Date shall be determined by Landlord and written notice of the amount thereof (the “**Notice**”) shall be given to Tenant not later than ninety (90) days prior to the date on which the Option Term is scheduled to commence, subject to Tenant’s right to arbitration as hereinafter provided. Failure on the part of Tenant to demand arbitration within thirty (30) days after receipt of the Notice from Landlord shall bind Tenant to the Fair Market Rental as determined by Landlord. Should Tenant elect to arbitrate and should the arbitration not be concluded prior to the Adjustment Date, Tenant shall pay the Annual Rental to Landlord after the Adjustment Date, adjusted to reflect the Fair Market Rental as Landlord has so determined. If the amount of the Fair Market Rental as determined by arbitration is greater than or less than Landlord’s determination, then any adjustment required to adjust the amount previously paid shall be made by payment by the appropriate party within ten (10) days after such determination of Fair Market Rental.

If Tenant disputes the amount claimed by Landlord as Fair Market Rental, Tenant may require that Landlord submit the dispute to arbitration. The arbitration shall be conducted and determined in the City and County of San Francisco, California in accordance with the then prevailing rules of the American Arbitration Association or its successor for arbitration of commercial disputes, except that the procedures mandated by such rules shall be modified as follows:

(i) Tenant shall make demand for arbitration in writing within thirty (30) days after service of the Notice, specifying therein the name and address of the person to act as the arbitrator on Tenant's behalf. The arbitrator shall be a competent and impartial real estate broker with at least five (5) years' full-time commercial real estate brokerage experience with comparable retail space in the City and County of San Francisco, California. Failure on the part of Tenant to make the timely and proper demand for such arbitration shall constitute a waiver of the right thereto. Within fifteen (15) days after the service of the demand for arbitration, Landlord shall give notice to Tenant specifying the name and address of the person designated by Landlord to act as arbitrator on its behalf, which arbitrator shall be similarly qualified. If Landlord fails to notify Tenant of the appointment of its arbitrator, within or by the time specified, then the arbitrator appointed by Tenant shall be the arbitrator to determine the Fair Market Rental for the Premises.

(ii) If two arbitrators are chosen pursuant to paragraph (i) above, the arbitrators so chosen shall meet within ten (10) business days after the second arbitrator is appointed and shall appoint a third arbitrator, who shall be a competent and impartial person with qualifications similar to those required of the first two arbitrators pursuant to paragraph (i) above. If they are unable to agree upon such appointment within five (5) business days after expiration of such ten (10) business day period, the third arbitrator shall be selected by the parties themselves. If the parties do not so agree, then either party, on behalf of both, may request appointment of such a qualified person by the then presiding judge of the City and County of San Francisco Superior Court. The three arbitrators shall decide the dispute, if it has not been previously resolved, by following the procedures set forth in paragraph (iii) below.

(iii) The Fair Market Rental shall be fixed by the three arbitrators in accordance with the following procedures. Each of the arbitrators selected by the parties shall state, in writing, his determination of the Fair Market Rental supported by the reasons therefor and shall make counterpart copies for each of the other arbitrators. The arbitrators shall arrange for a simultaneous exchange of such proposed resolutions. The role of the third arbitrator shall be to select which of the two proposed resolutions most closely approximates his determination of Fair Market Rental. The third arbitrator shall have no right to propose a middle ground or any modification of either of the two proposed resolutions. The resolution he chooses as that most closely approximating his determination of the Fair Market Rental shall constitute the decision of the arbitrators and shall be final and binding upon the parties.

(iv) In the event of a failure, refusal or inability of any arbitrator to act, his successor shall be appointed by him, but in the case of the third arbitrator, his successor shall be appointed in the same manner as that set forth herein with respect to the appointment of the original third arbitrator. The arbitrators shall attempt to decide the issue within ten (10) business days after the appointment of the third arbitrator. Any decision in which the arbitrator appointed by Landlord and the arbitrator appointed by Tenant concur shall be binding and conclusive upon the parties, except that such arbitrators shall not attempt by themselves to mutually ascertain the Fair Market Rental and any such determination, in a manner other than that provided for in paragraph (iii) hereof, shall not be binding on the parties. Each party shall pay the fees and expenses of its respective arbitrator and both shall share the fees and expenses of the third arbitrator. Attorneys' fees and expenses of counsel and of witnesses for the respective parties shall be paid by the respective party engaging such counsel or calling such witnesses.

(v) The arbitrators shall have the right to consult experts and competent authorities for factual information or evidence pertaining to a determination of Fair Market Rental, but any such

consultation shall be made in the presence of both parties with full right on their part to cross-examine. The arbitrators shall render the decision and award in writing with counterpart copies to each party. Except for the establishment of Fair Market Rental as herein provided, the arbitrators shall have no power to modify the provisions of the Lease.

If Tenant exercises its option to extend the Term of the Lease for an Option Term in accordance with this Addendum, Tenant shall promptly remodel the Premises, at Tenant's sole cost and expense, consistent with its then-current restaurant prototype ("**Tenant's Extension Remodel**"). In performing Tenant's Extension Remodel, Tenant shall comply with the requirements of Article 10 of the Base Lease, including but not limited to adherence with the Design Review Process and the Tenant Design Guidelines.

Lease Analysis Summary

**TIPA - Dry Comparison Summary**

Tenant	Station	GSF	10-Year Rent	TI Cost	Actual / DI	Mass Building RCMA	Net	GSF	10-Year Rent	TI Cost	Pre-Ferms	Mass Building Budget	Net	Difference	Net
			(\$/SqF)	(\$)		(\$)	(\$)		(\$)	(\$)	(\$)	(\$)	(\$)	(\$)	(\$)
Charity's	139	671	\$1,699,714	\$971,100	\$711,604	\$480,730	571,874	139	\$1,699,714	\$971,100	\$711,604	\$3,929,769	\$4,701,495	\$0	\$411,115
Mega	123	691	\$752,546	\$547,735	\$204,811	\$48,827	598,914	123	\$752,546	\$547,735	\$204,811	\$3,929,769	\$4,701,495	\$0	\$411,115
Brooks SF	207, 208, 212	3,328	\$2,207,774	\$1,520,000	\$687,774	\$19,056,624	207, 208, 212	3,328	\$2,207,774	\$1,520,000	\$687,774	\$1,137,232	\$1,137,232	\$0	\$0
Protein Dental	218, 219, 220	3,475	\$1,887,774	\$1,325,000	\$562,774	\$14,047	1,325,000	3,475	\$1,887,774	\$1,325,000	\$562,774	\$1,008,666	\$1,008,666	\$0	\$0
Philly	100	2,157	\$1,654,569	\$1,215,000	\$439,569	\$1,481,321	100	2,157	\$1,654,569	\$1,215,000	\$439,569	\$1,187,802	\$1,187,802	\$0	\$0
Philly	143	1,041	\$1,790,285	\$1,044,000	\$746,410	\$1,233,555	143	1,041	\$1,790,285	\$1,044,000	\$746,410	\$1,026,872	\$1,026,872	\$0	\$0
Kaiser	200	3,996	\$2,834,443	\$2,318,688	\$515,755	\$1,889,167	200	3,996	\$2,834,443	\$2,318,688	\$515,755	\$2,429,436	\$2,429,436	\$0	\$0
Philly	171	2,800	\$2,731,463	\$2,372,500	\$358,963	\$1,888,278	171	2,800	\$2,731,463	\$2,372,500	\$358,963	\$447,244	\$447,244	\$0	\$0
Simon Motion	123	2,800	\$2,731,463	\$2,372,500	\$358,963	\$1,888,278	123	2,800	\$2,731,463	\$2,372,500	\$358,963	\$447,244	\$447,244	\$0	\$0
Simon Motion	123	2,800	\$2,731,463	\$2,372,500	\$358,963	\$1,888,278	123	2,800	\$2,731,463	\$2,372,500	\$358,963	\$447,244	\$447,244	\$0	\$0
Dams, LLC	107 & 111	1,877	\$3,865,555	\$1,824,424	\$2,041,131	\$1,463,700	1,877	\$3,865,555	\$1,824,424	\$2,041,131	\$2,041,131	\$557,958	\$557,958	\$0	\$0
Position	141	1,108	\$1,925,837	\$1,192,800	\$733,037	\$469,897	1,108	\$1,925,837	\$1,192,800	\$733,037	\$311,576	\$311,576	\$0	\$0	
SSS ONE, LLC	119	4,468	\$4,331,568	\$3,340,000	\$991,568	\$559,913	119	4,468	\$4,331,568	\$3,340,000	\$991,568	\$1,466,070	\$1,466,070	\$0	\$0
Happy Lemon	105	835	\$939,380	\$733,440	\$205,940	\$169,710	105	835	\$939,380	\$733,440	\$205,940	\$449,429	\$449,429	\$0	\$0
Spring Family	232 & 234	2,541	\$3,108,189	\$1,925,000	\$1,183,189	\$771,000	2,541	\$3,108,189	\$1,925,000	\$1,183,189	\$825,476	\$825,476	\$0	\$0	
Spring House (12 mos)	137	1,075	\$1,126,635	\$666,675	\$459,960	\$282,013	1,075	\$1,126,635	\$666,675	\$459,960	\$311,909	\$311,909	\$0	\$0	
Spring House (12 mos)	145	1,435	\$1,435,000	\$925,000	\$510,000	\$325,000	1,435	\$1,435,000	\$925,000	\$510,000	\$510,000	\$510,000	\$0	\$0	
<b>Total</b>		<b>63,135</b>	<b>\$47,684,092</b>	<b>\$27,484,962</b>	<b>\$20,199,194</b>	<b>\$13,401,138</b>	<b>\$27,484,962</b>	<b>63,135</b>	<b>\$47,684,092</b>	<b>\$27,484,962</b>	<b>\$20,199,194</b>	<b>\$11,589,168</b>	<b>\$27,484,962</b>	<b>\$0</b>	<b>\$2,788,947</b>

**TIPA - Contractual Rent Summary (\$0 - 15 years)**

Tenant	Station	GSF	Contractual Rent	Actual / DI	Mass Building RCMA	Net	GSF	Contractual Rent	Actual / DI	Mass Building Budget	Net	Difference	Net
			(\$/SqF)		(\$)	(\$)		(\$)		(\$)	(\$)	(\$)	(\$)
Charity's	139	671	\$1,699,714	\$971,100	\$711,604	\$480,730	139	\$1,699,714	\$971,100	\$711,604	\$3,929,769	\$4,701,495	\$411,115
Mega	123	691	\$752,546	\$547,735	\$204,811	\$48,827	123	\$752,546	\$547,735	\$204,811	\$3,929,769	\$4,701,495	\$411,115
Brooks SF	207, 208, 212	3,328	\$2,207,774	\$1,520,000	\$687,774	\$19,056,624	207, 208, 212	3,328	\$2,207,774	\$1,520,000	\$687,774	\$1,137,232	\$1,137,232
Protein Dental	218, 219, 220	3,475	\$1,887,774	\$1,325,000	\$562,774	\$14,047	3,475	\$1,887,774	\$1,325,000	\$562,774	\$1,008,666	\$1,008,666	
Philly	100	2,157	\$1,654,569	\$1,215,000	\$439,569	\$1,481,321	100	2,157	\$1,654,569	\$1,215,000	\$439,569	\$1,187,802	\$1,187,802
Philly	143	1,041	\$1,790,285	\$1,044,000	\$746,410	\$1,233,555	143	1,041	\$1,790,285	\$1,044,000	\$746,410	\$1,026,872	\$1,026,872
Kaiser	200	3,996	\$2,834,443	\$2,318,688	\$515,755	\$1,889,167	200	3,996	\$2,834,443	\$2,318,688	\$515,755	\$2,429,436	\$2,429,436
Philly	171	2,800	\$2,731,463	\$2,372,500	\$358,963	\$1,888,278	171	2,800	\$2,731,463	\$2,372,500	\$358,963	\$447,244	\$447,244
Simon Motion	123	2,800	\$2,731,463	\$2,372,500	\$358,963	\$1,888,278	123	2,800	\$2,731,463	\$2,372,500	\$358,963	\$447,244	\$447,244
Simon Motion	123	2,800	\$2,731,463	\$2,372,500	\$358,963	\$1,888,278	123	2,800	\$2,731,463	\$2,372,500	\$358,963	\$447,244	\$447,244
Dams, LLC	107 & 111	1,877	\$3,865,555	\$1,824,424	\$2,041,131	\$1,463,700	1,877	\$3,865,555	\$1,824,424	\$2,041,131	\$2,041,131	\$557,958	\$557,958
Position	141	1,108	\$1,925,837	\$1,192,800	\$733,037	\$469,897	1,108	\$1,925,837	\$1,192,800	\$733,037	\$311,576	\$311,576	
SSS ONE, LLC	119	4,468	\$4,331,568	\$3,340,000	\$991,568	\$559,913	119	4,468	\$4,331,568	\$3,340,000	\$991,568	\$1,466,070	\$1,466,070
Happy Lemon	105	835	\$939,380	\$733,440	\$205,940	\$169,710	105	835	\$939,380	\$733,440	\$205,940	\$449,429	\$449,429
Spring Family	232 & 234	2,541	\$3,108,189	\$1,925,000	\$1,183,189	\$771,000	2,541	\$3,108,189	\$1,925,000	\$1,183,189	\$825,476	\$825,476	
Spring House (12 mos)	137	1,075	\$1,126,635	\$666,675	\$459,960	\$282,013	1,075	\$1,126,635	\$666,675	\$459,960	\$311,909	\$311,909	
Spring House (12 mos)	145	1,435	\$1,435,000	\$925,000	\$510,000	\$325,000	1,435	\$1,435,000	\$925,000	\$510,000	\$510,000	\$510,000	
<b>Total</b>		<b>63,135</b>	<b>\$47,684,092</b>	<b>\$27,484,962</b>	<b>\$20,199,194</b>	<b>\$13,401,138</b>	<b>63,135</b>	<b>\$47,684,092</b>	<b>\$27,484,962</b>	<b>\$20,199,194</b>	<b>\$11,589,168</b>	<b>\$27,484,962</b>	<b>\$2,788,947</b>