

# Phase 2 Update

October 12, 2017



# Agenda

- Preliminary Engineering Design Submittals
  - Right-of-Way
  - BART/Muni Pedestrian Connector
- Ridership Study
- Rail Operations Study
- Tunnel Options Study
- Phase 2 Next Steps



# Preliminary Engineering Design Submittals

---

- 22 draft design submittals have been received since funding approved:
  - Rail: Trackwork, overhead catenary system, signals, communications, water/air
  - Civil (2<sup>nd</sup> St.): Traffic, streetwork, utilities
  - Right-of-way (2<sup>nd</sup> St.): Existing structures underpinning assessments, noise and vibration
  - BART/Muni Pedestrian Connector: Fire & life safety, streetwork, utilities, traffic, geotechnical

# Right-of-Way

- Assessed impacted buildings identified in the Draft SEIS/EIR (2<sup>nd</sup> & Howard St area):
  - 171 Second Street
  - 235 Second Street
  - 589 Howard Street
- Underpinning feasible regardless of DTX construction method
- No demolition of occupied spaces will be necessary



# BART/Muni Pedestrian Connector

- Plan & estimate development
- Pedestrian circulation
- Fire & life safety coordination with SFFD and BART
- October 4<sup>th</sup> presentation to BART and AC Interagency Liaison Committee (ILC) Meeting



# Ridership Study

- Updating ridership for: 4<sup>th</sup>/Townsend St. Station, Transit Center, & BART/Muni Pedestrian Connector
- Reviewing existing data collected in July from Caltrain, CHSRA, and SFCTA
- Anticipated to be completed in late November



# Rail Operations Study Goals

- Determine the infrastructure needs to deliver a modern rail terminal for both current and future train service
  - Design life of 100 years
  - Allow for future expansion of rail service
- Work in collaboration with CHSRA and Caltrain



# Rail Operations Study

---

- Analyzed both two- and three-track alignments for DTX
- Operators provided:
  - Proto-typical timetable that includes blended service to San Jose
  - Dwell times
  - Train set inputs
  - Assumed incident durations





# Rail Operations Metrics

---

- “Unacceptable delay” is anything that impacts the ability to deliver at least 95% on time performance.
- “Systemwide delays” means that single-tracking in San Francisco yields delay to **all** trains on the system, meaning all passengers are affected by a single event.
- Incidents that cause train delay are to be expected; they are not exceptional:
  - Medical issues
  - Longer dwells caused by bike loading/unloading or disabled passenger loading/unloading

# Rail Operations Study Conclusions

---

- 3 tracks are necessary. The 3<sup>rd</sup> track:
  - Reduces delay during incident scenarios impacting other tracks
  - Delivers quicker recovery to planned schedules reducing potential impacts on both CHSRA and Caltrain networks
  - Provides increased flexibility for train operations to and from the Transit Center which is critical to reliable service delivery in a modern transport hub
  - Allows for future growth

# Tunnel Options Study Purpose & Goals

---

- Initiated to address potential impacts resulting from cut-and-cover construction
- Goals:
  - Minimize surface disruption and socio-economic impacts
  - Reduce cut-and-cover tunnel extent
  - Identify feasible mined tunnel construction methods for further study
  - Identify major infrastructure constraints

# Tunnel Options Study Participants

---

- SFCTA
- TJPA
- CHSRA / WSP
- Caltrain (briefed)
- SFMTA
- AECOM
- Brierley Associates
- Parsons
- McMillen Jacobs
- Mott MacDonald
- EPC

# Tunnel Option Study Timeline



**Study Initiated/Preliminary Analysis** April 25 – May 30

**Analysis/Coordination with Tunneling Experts** May 30 - July 27

**Reporting/Cost, Schedule & Risk Assessment** July 27 - September 8

**Presentation of Preliminary Findings to SFCTA** September 26

# Tunnel Option Study Extents

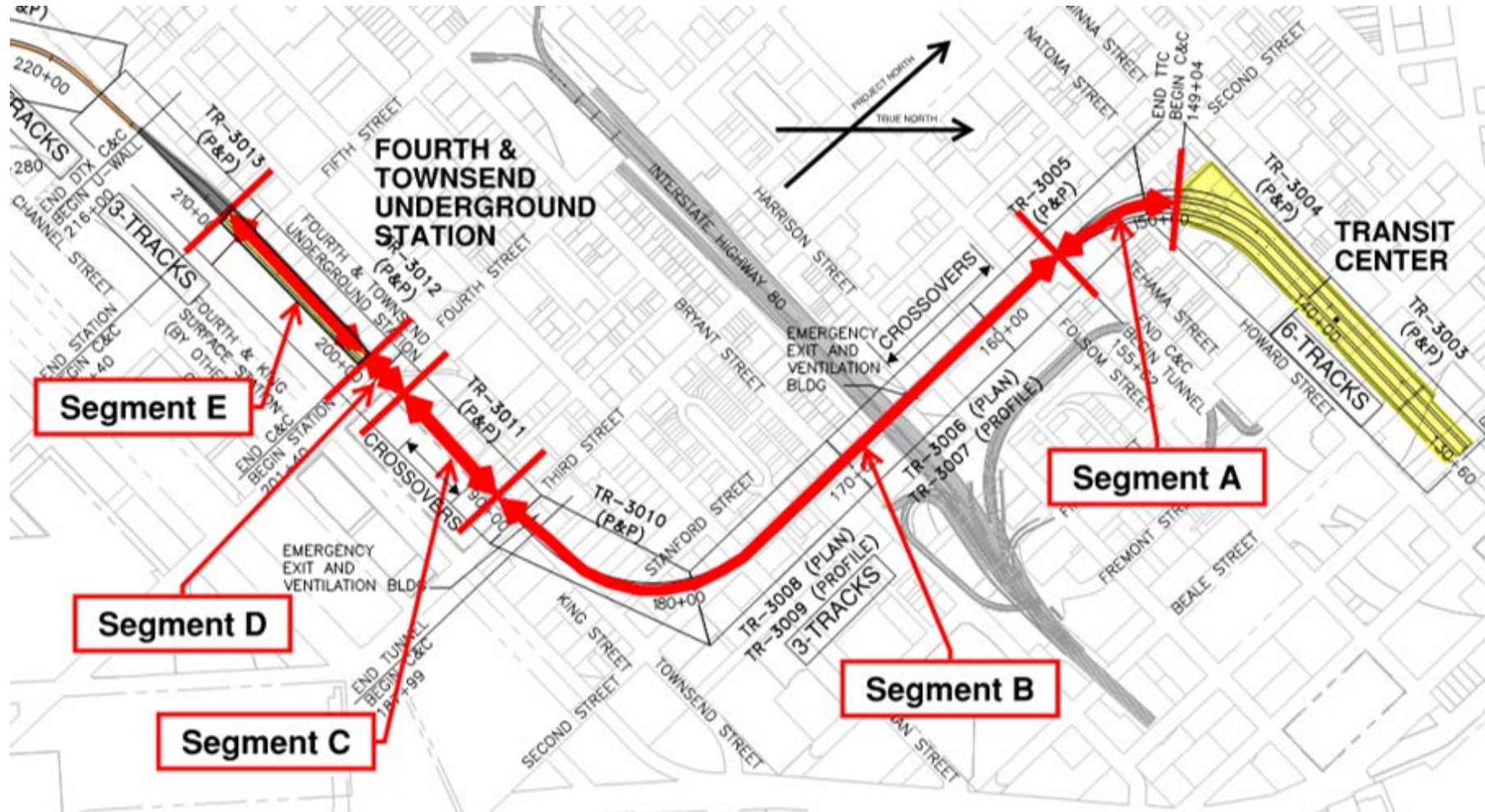

# Subsurface Conditions

Limits of baseline  
mined tunnel segment

4<sup>th</sup>/Townsend  
St Station

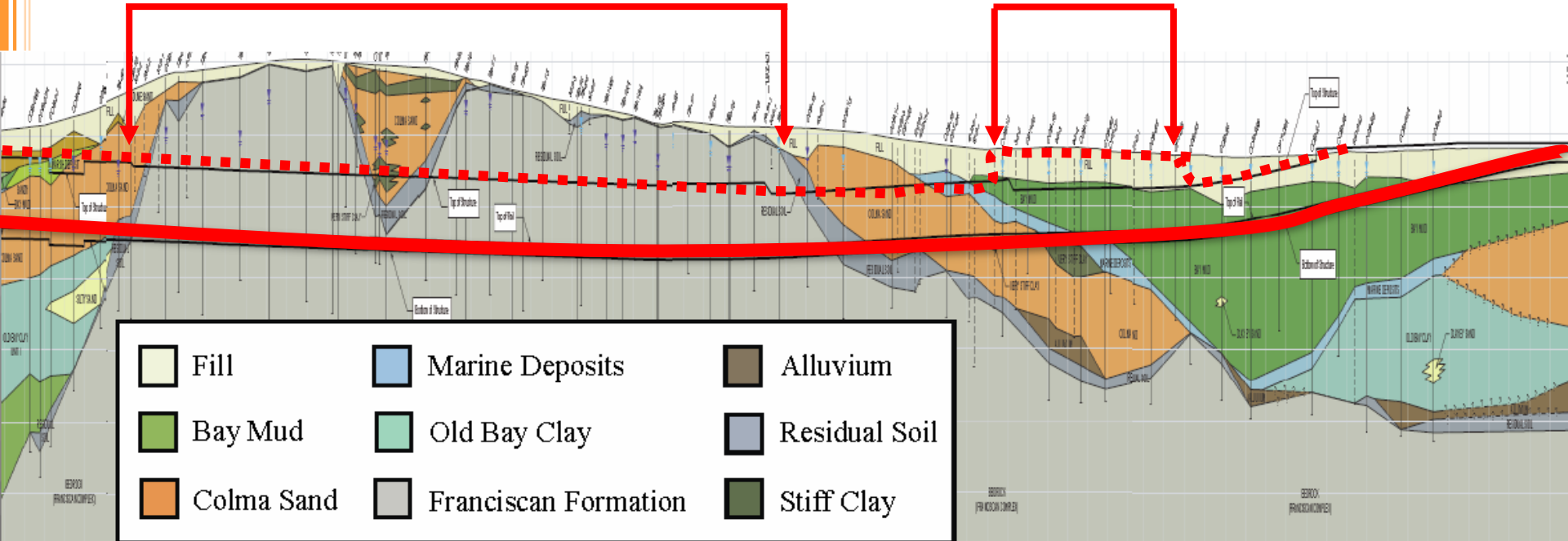

Tunnel Crown

Tunnel Invert

# Risk Evaluation Criteria

---

- Constructability (*incl. availability of staging area*)
- Design complexity (*level of effort involved to develop the design*)
- Ground & groundwater conditions
- Residential/business, traffic and utility impact
- Right-of-way and protection of existing structures
- Environmental impacts (*incl. noise, vibration, dust, visual/aesthetic issues*)
- Construction cost and schedule
- Future development potential (*over alignment*)



# Tunneling Methods Considered

- Pipe arch without pre-support walls
- Stacked drift pre-support side walls without vertical pier supports

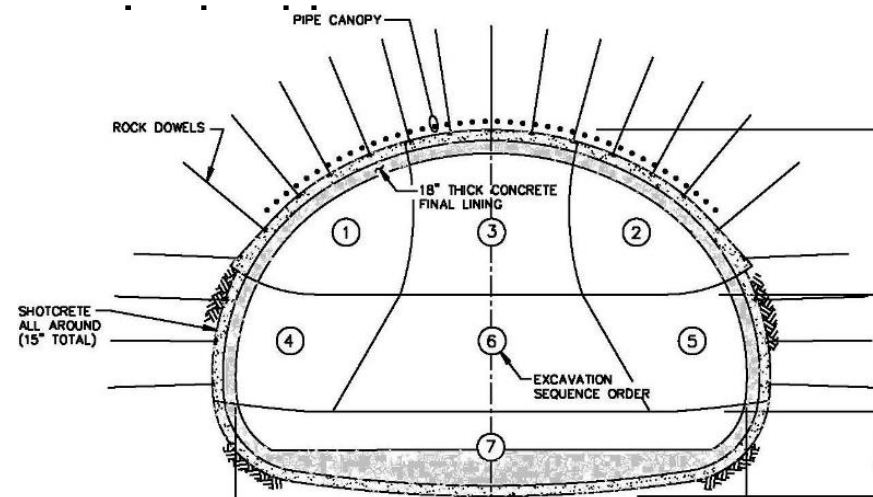

- Sequential excavation

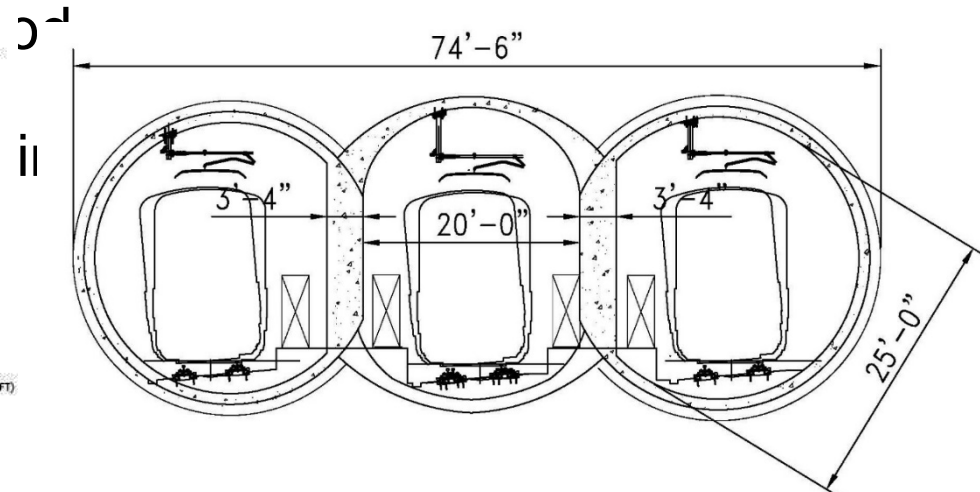
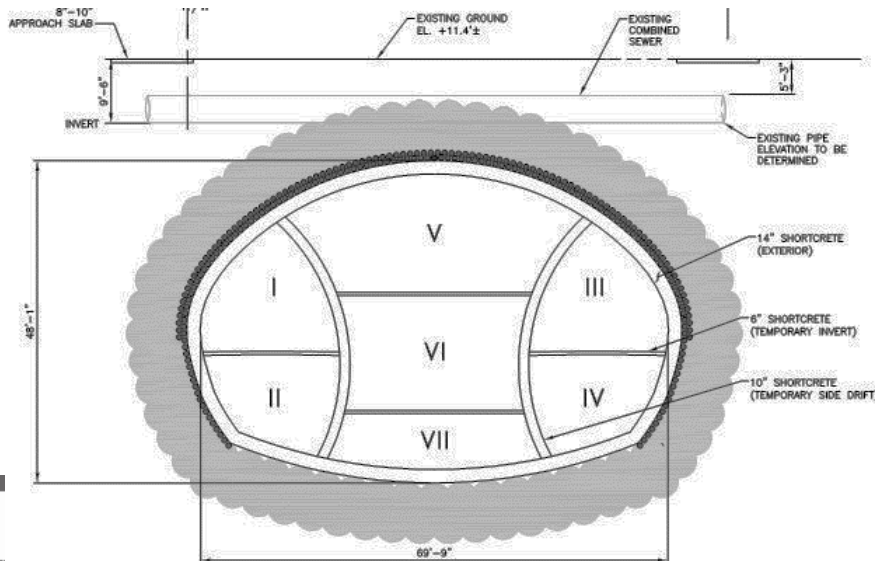

# Tunnel Options Summary

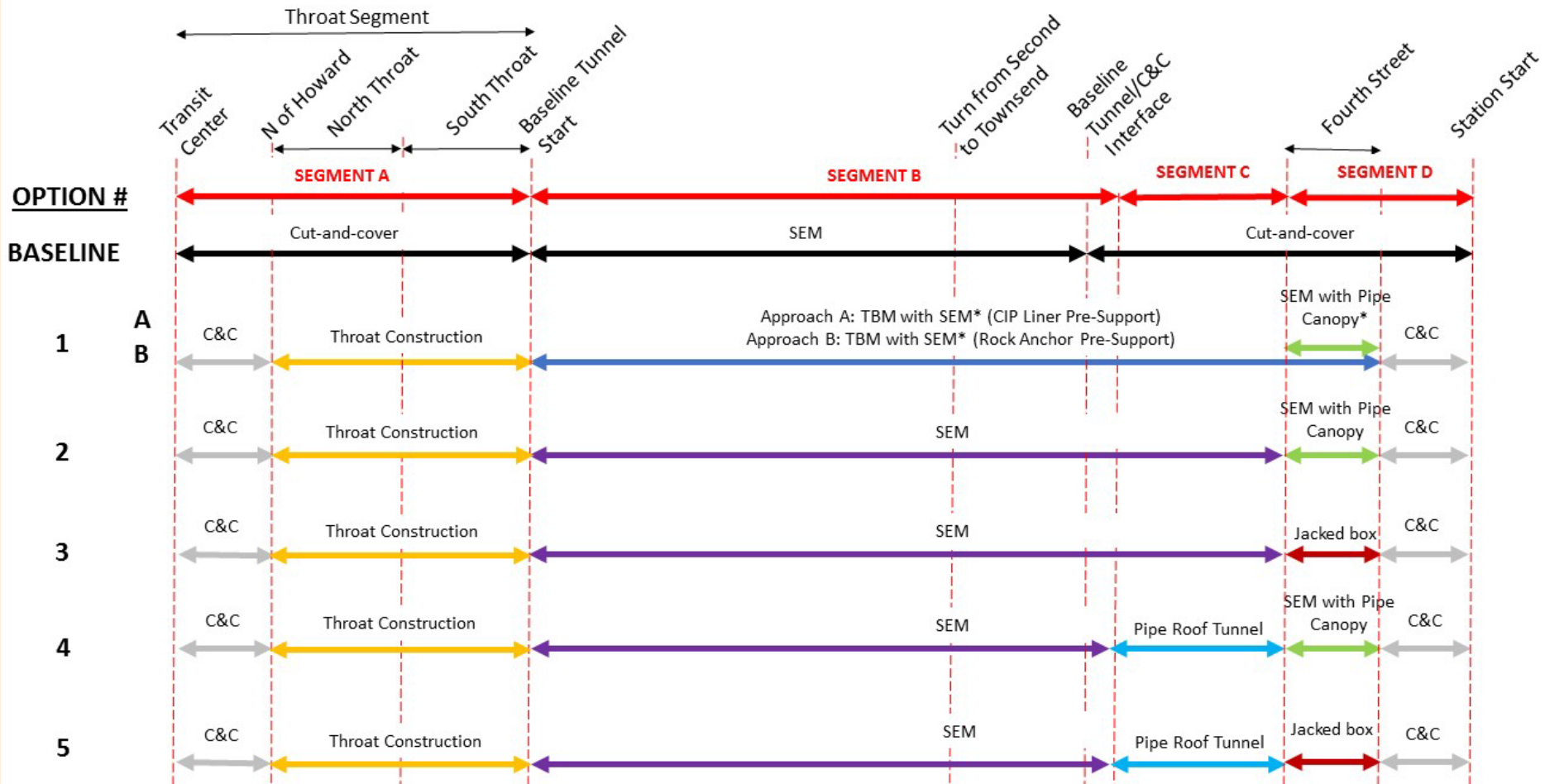

# Tunnel Options Study Preliminary Findings

---

- Elimination of cut-and-cover:
  - Feasible on Townsend Street up to the east end of the Fourth and Townsend Street Station at reasonable cost
  - Feasible at Throat Structure (located at Second/Howard Sts.), but costly
- Preferred tunneling options can be accomplished without significant impacts to the project schedule
- Impacts to Central Subway will be minor and can be mitigated
- The Fourth and Townsend Street Station must be constructed by cut-and-cover construction

# Relative Cut-and-Cover Extents (Baseline vs. Reduction)



# Temporary Traffic Decking

- Steel beams and concrete panels used to minimize traffic disruption by providing a temporary road surface
- Installation at nights and on weekends to limit traffic impacts
- Use:
  - Townsend St. between 4<sup>th</sup> and 6<sup>th</sup> Sts.
  - Second/Howard Streets (Throat Area)

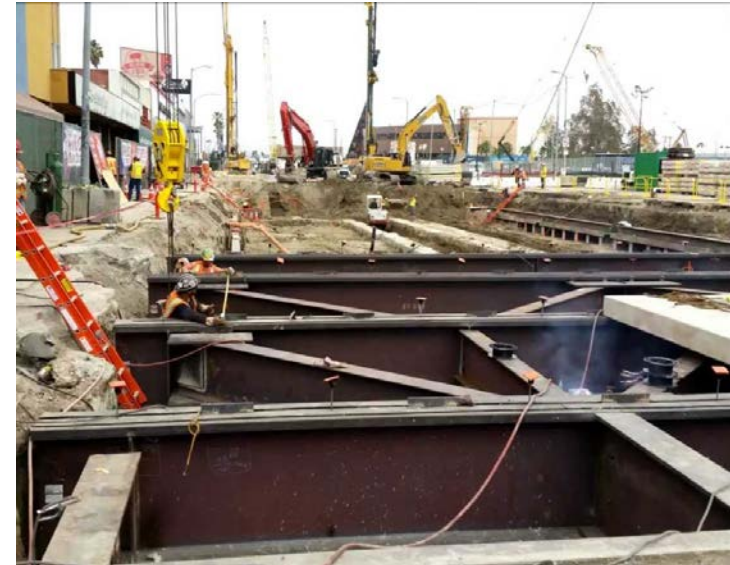

# Tunnel Options Study Next Steps

---

- Further develop mined crossing of Howard Street to balance surface disruption and cost for the Throat Structure
- Refine the constructability and schedule for the preferred tunneling options
- Review configuration of the TBM + SEM tunneling option
- Confirm ventilation requirements

# Phase 2 Next Steps

---

- Update funding plan with results from ridership study
- Coordinate delivery schedule with BART for the BART/Muni Pedestrian Connector and reach agreement on operation and maintenance responsibilities
- Develop delivery plan based on the results of the RAB Study

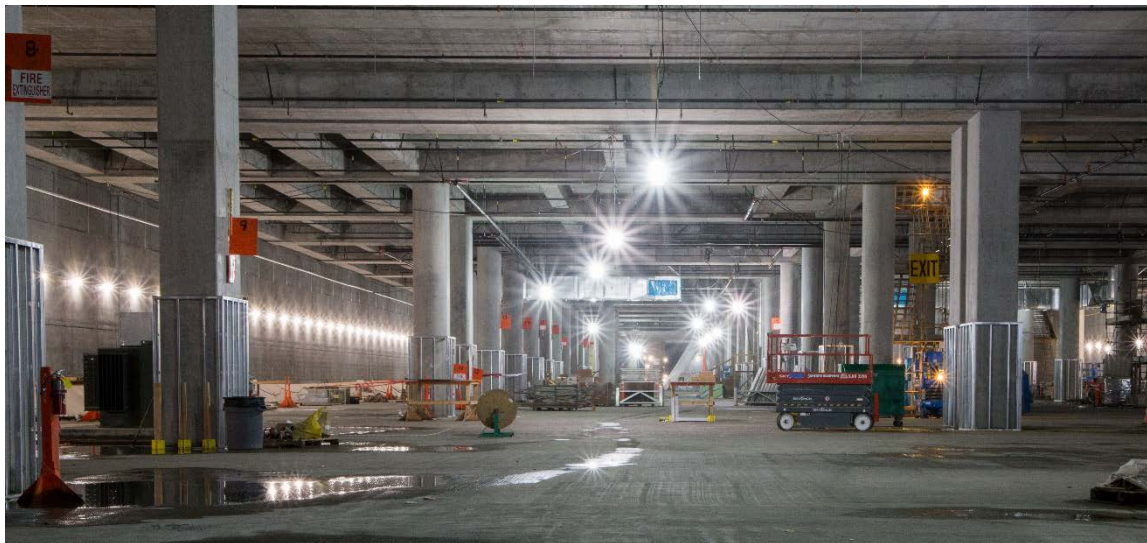



# Questions?

**TJPA**  
TRANSBAY JOINT POWERS AUTHORITY

201 Mission Street, Suite 2100 San Francisco, CA 94105 • 415.597.4620 • [www.tjpa.org](http://www.tjpa.org)